

CONTROL SYSTEMS



Individual Control

Centralized Control

Intelligent Control

AIR
CONDITIONING
SOLUTION

Overview

Model	Wired Controller HYXE-VC01	Wired Controller HYXM-VG01	Wired Controller HYXE-VA01A	Wired Controller HYXE-S01H	Wireless Controller HYE-VD01
Picture					
Max. connectable indoor units	6	16	16	16	—
Power supply	15V	15V	15V	15V	3V
Dimension(mm)	86*86	120*120	120*120	120*70	178.6*47.8
Cool/Heat/Fan/Auto/Dry	●	●	●	●	●
Auto dehumidification(humidity sensor)	●	●	●	●	×
Fan speed	●	●	●	●	●
Louver setting	●	●	●	●	●
Temperature setting	●	●	●	●	●
Operation monitoring	●	●	●	●	×
Timer	●	●	●	●	●
7-day timer	×	●	×	×	×
Holiday setting	×	●	×	×	×
Main-sub connection	●	×	●	×	×
Main-sub control	×	●	×	×	×
Change indoor address	●	●	●	×	×
Check function	●	●	●	●	×
Option setting	●	●	●	●	×
Air filter cleaning reminding	●	●	●	●	×
Error code display	●	●	●	●	×
Auto test run	●	●	●	●	●
Indoor/outdoor PCB checking	●	●	●	●	×
Self diagnostic function	●	●	●	●	●
Back light	●	●	●	●	●
Built-in temperature sensor	●	●	●	×	●
Wireless control available	●	●	×	×	—
Individual louver control	●	●	●	×	●
Breeze mode	●	●	●	×	×
Motion sensor	×	●	●	×	×
Health(Airpure)	●	●	●	×	●
High-temp sterilization	×	●	×	×	×
Hi-Motion	×	●	×	×	×
ECO (energy saving)	●	●	●	×	●
Quiet (Indoor unit)	●	●	●	●	●
Sleep(Indoor unit)	●	●	●	×	●
Window interlock	●	●	●	×	×
Key card	●	●	●	×	×
3D-air flow	●	●	●	×	●
Child lock	●	●	×	×	×
Self cleaning	●	●	●	×	●
Auto changeover	×	●	×	×	×
Dynamic ESP	●	●	×	×	×
Outlet air temp limit	●	●	×	×	×

Remarks: Available: ● Unavailable: ×

RELIABILITY

EFFICIENCY

COMFORT





FLEXIBILITY







OUTDOOR UNIT

INDOOR UNIT

CONTROL SYSTEM

ACCESSORY

Type	Wired Controller				Wireless Controller
Model	HYXE-VC01	HYXM-VG01	HYXE-VA01A	HYXE-S01H	HYE-VD01
Picture					
Indoor Unit					
4-Way Cassette	○	○	○	○	○
Mini 4-Way Cassette	○	○	○	○	○
1-Way Cassette	○	○	○	×	○
2-Way Cassette	○	○	○	×	○
Ceiling Ducted (AC/DC)	○	○	○	○	○
Ceiling Ducted (High/Low)	○	○	○	○	○
Console	○	○	○	○	●
Wall Mounted	○	○	○	○	●
Ceiling & Floor	○	○	○	○	●
Floor Concealed	○	○	○	×	○
All Fresh Air	○	○	○	○	○
Heat Recovery Ventilator	×	×	×	×	×
AHU Kit	○	○	●	×	×

Type	Receiver Kit				Centralized Controller	ON/OFF
Model	HYRE-V02H	HYRE-Z01H	HYRE-T03H	HYRE-X01H	HYJM-RA10D	HYJ-J01H
Picture						
Indoor Unit						
4-Way Cassette	×	×	○	×	○	○
Mini 4-Way Cassette	×	○	×	×	○	○
1-Way Cassette	×	×	×	○	○	○
2-Way Cassette	○	×	×	×	○	○
Ceiling Ducted (AC/DC)	○	×	×	×	○	○
Ceiling Ducted (High/Low)	○	×	×	×	○	○
Console	○	×	×	×	○	○
Wall Mounted	○	×	×	×	○	○
Ceiling & Floor	○	×	×	×	○	○
Floor Concealed	○	×	×	×	○	○
All Fresh Air	○	×	×	×	○	○
Heat Recovery Ventilator	×	×	×	×	○	○

Remarks: Standard: ● Optional: ○ Incompatible: ×

Individual Control

Wired Controller

HYXE-VC01



Mode	Cool/Heat/Auto/Fan/Dry
Timer	24-hour timer
Maintenance	Error code/Parameter check/Auto test run/ Self diagnostic function/Indoor & Outdoor PCB checking/ Air filter cleaning reminding/IDU address setting
Louver	7 Louver setting/3D-air flow/Individual louver control
Special function	Health/ECO/Quiet/Sleep/Self-cleaning
Fan speed	6
Temperature setting	0.5°C accuracy/Display the setting temp. or room temp.
Main-sub control	•
Wireless control available	•
Built-in temperature sensor	•

Features

- Size: 86mm × 86mm
- Max. connectable indoor units: 6
- LCD display with back light
- Touch button
- Flat back-cover for easy mounting

HYXM-VG01



Mode	Cool/Heat/Auto/Fan/Dry
Timer	24-hour/Weekly schedule/Holiday setting
Maintenance	Error code/Parameter check/Auto test run/ Indoor&Outdoor PCB checking/Self diagnostic function
Louver	Louver setting/Individual louver control/3D-air flow
Special function	Breeze mode/Motion sensor/Health/ Hi-Motion/ECO/Quiet/Sleep
Fan speed	6
Temperature setting	0.5°C
Main-sub control	•
Air filter cleaning reminding	•
Back light	•
Built-in temperature sensor	•
Built-in receiver kit	•

Features

- Size: 120mm × 120mm
- Max. connectable indoor units: 16
- Touch button
- Language:
Support 11 languages: English,
French, German, Italian, Spanish,
Dutch, Portuguese, Polish, Turkish,
Russian, Arabic
- Diverse Display Colors
- Brand-new Auto Changeover
- Refrigerant Leakage Alarm

HYXE-VA01A



Features

Mode	Cool/Heat/Auto/Fan/Dry
Timer	72-hour
Maintenance	Error code/Parameter check/Auto test run/ Indoor&Outdoor PCB checking/Self diagnostic function
Louver	Louver setting/Individual louver control/3D-air flow
Special function	Breeze mode/Motion sensor/Health/ECO/Quiet/ Sleep/Self-cleaning
Fan speed	6
Temperature setting	0.5°C
Main-sub control	•
Air filter cleaning reminding	•
Back light	•
Built-in temperature sensor	•

- Size: 120mm × 120mm
- Max. connectable indoor units: 16
- LCD display
- Touch button

Wireless Controller

HYE-VD01



Features

Mode	Cool/Heat/Auto/Fan/Dry
Timer	24-hour timer
Maintenance	Auto test run/Self diagnostic function/ Identification of adjacent receiver
Louver	Louver setting/3D-air flow*/Individual louver control
Special function	Health/ECO/Quiet/Sleep/Self-cleaning
Fan speed	6
Temperature setting	1°C accuracy/Display the setting temp. or room temp.
Built-in temperature sensor	•

- Size: 178.6mm × 47.8mm
- LCD display with back light

*When used to control 3D air-flow Panels, an additional receiver kit of wireless control will be necessary.

HYXE-S01H



Features

Mode	Cool/Heat/Auto/Fan/Dry/Quiet
Timer	24-hour
Maintenance	Error code/Parameter check/Auto test run/ Indoor&Outdoor PCB checking/Self diagnostic function
Louver	Louver setting
Fan speed	6
Temperature control	•
Air filter cleaning reminding	•

- Size: 120mm × 70mm
- Max. connectable indoor units: 16
- LCD display
- Touch button

Receiver Kit for Wireless Control-Optional

HYRE-X01H

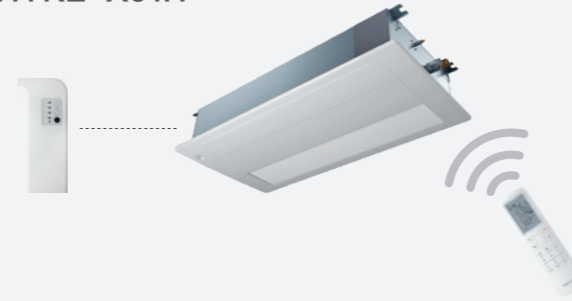

HYRE-V02H

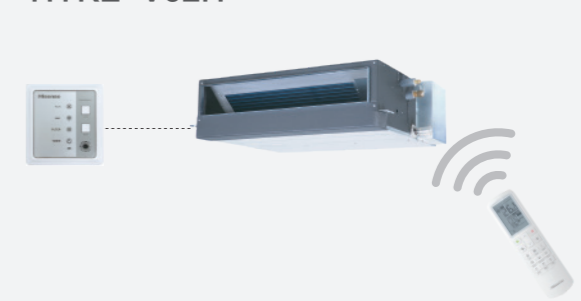

HYRE-Z01H

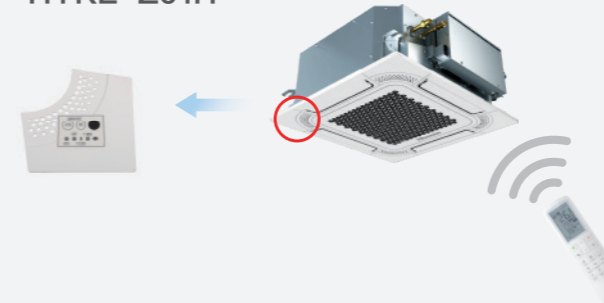

HYRE-T03H



Centralized Control

Smart Touch II
HYJM-RA10D



- Cool/Heat/Auto/Fan/Dry
- Remote control with web access
- Support rotation operation setting
- Weekly/Holiday timer
- Error reminder email
- External input/Output function
- ECO/Health/Self-cleaning/Quiet mode setting of the outdoor unit
- Support OTA update (remotely) and USB update (locally)

Features

- 10 inch colorful touch screen
- 1280 × 800 High Resolution
- Size: 170mm × 252mm × 37mm
- Connected quantity:
160 indoor units, 64 outdoor units
- 14 different languages:
English, French, Spanish, German, Italian, Dutch, Polish, Turkish, Russian, Arabic, Portuguese, Vietnamese, Thai, Chinese

Energy Management

Visualized energy management is available through the Smart Touch II, enabling quick access to electricity consumption data and analysis. Utilizing big data analytics.



Access Remotely with Ease

Users have the flexibility to control the air-conditioning system using either the local Smart Touch II or remote web access.

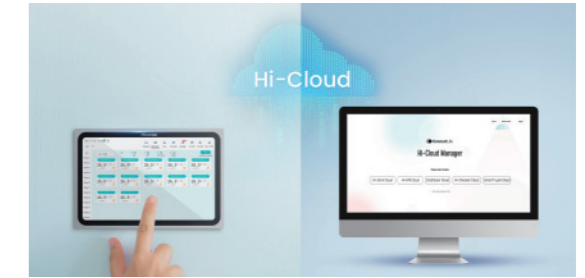

Free Connection

- Max. 4 Smart Touch controllers can be used in one system
- One controller can be connected to max. 160 IDUs, 64 ODUs

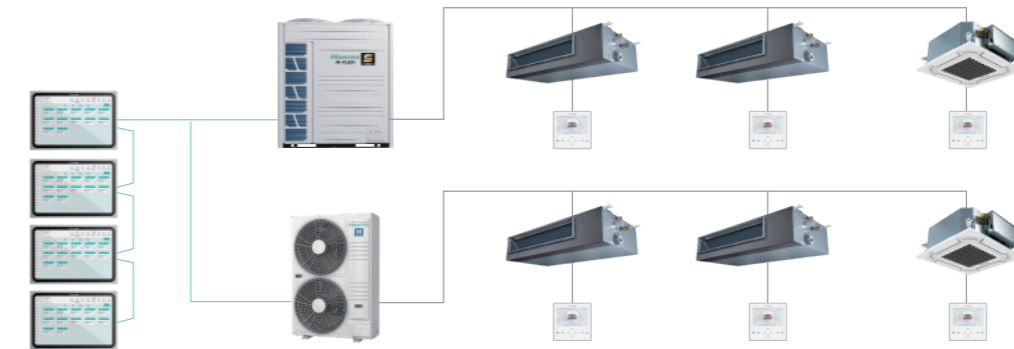

Future-proof

Ensure you stay up to date with both remote OTA updates and local USB updates.

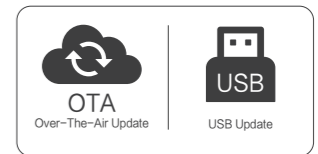

Ideal for:

Offices, Schools, Factories, Hospitals, Hotels, Restaurants



ON/OFF Controller
HYJ-J01H



Features

- Group control (ON/OFF)
- Indoor unit power OFF reminder
- Indoor units Auto log in
- Error reminder
- Size: 120mm × 120mm
- Max. connectable indoor units: 128
- Max. connectable indoor unit groups: 16
- Touch button