

Hisense

Qingdao Hisense HVAC Equipment Co.Ltd.
Add: 17, Donghai Xi Road, Qingdao, China.

<http://www.hisense-vrf.com> export@hisensehitachi.com [HisenseVRFGlobal](#) [@HisenseVRFGlobal](#) [Hisense VRF](#)



HCAC-CA-SHR01

★ Design and specifications are subject to change without notice. Pictures and diagrams are for reference only and are subject to change without notice.

Hisense VRF



HI-FLEXI S HEAT RECOVERY

WHY HISENSE VRF? BECAUSE IT...

- Adopts newest technology.
- Owens comprehensive product lineup.
- Maintains high efficiency performance with reliable quality.
- Provides modular combination design.
- Assures convenient and fast transportation and installation.
- Meets intelligent control system.
- Serves as a local team of sale, technical supports and maintenance.
- Wins an excellent reputation all over the world.

Contents

09
High Reliability

17
High Efficiency

23
Comfort

31
Convenience

53
Indoor Unit

85
Control System

Hisense

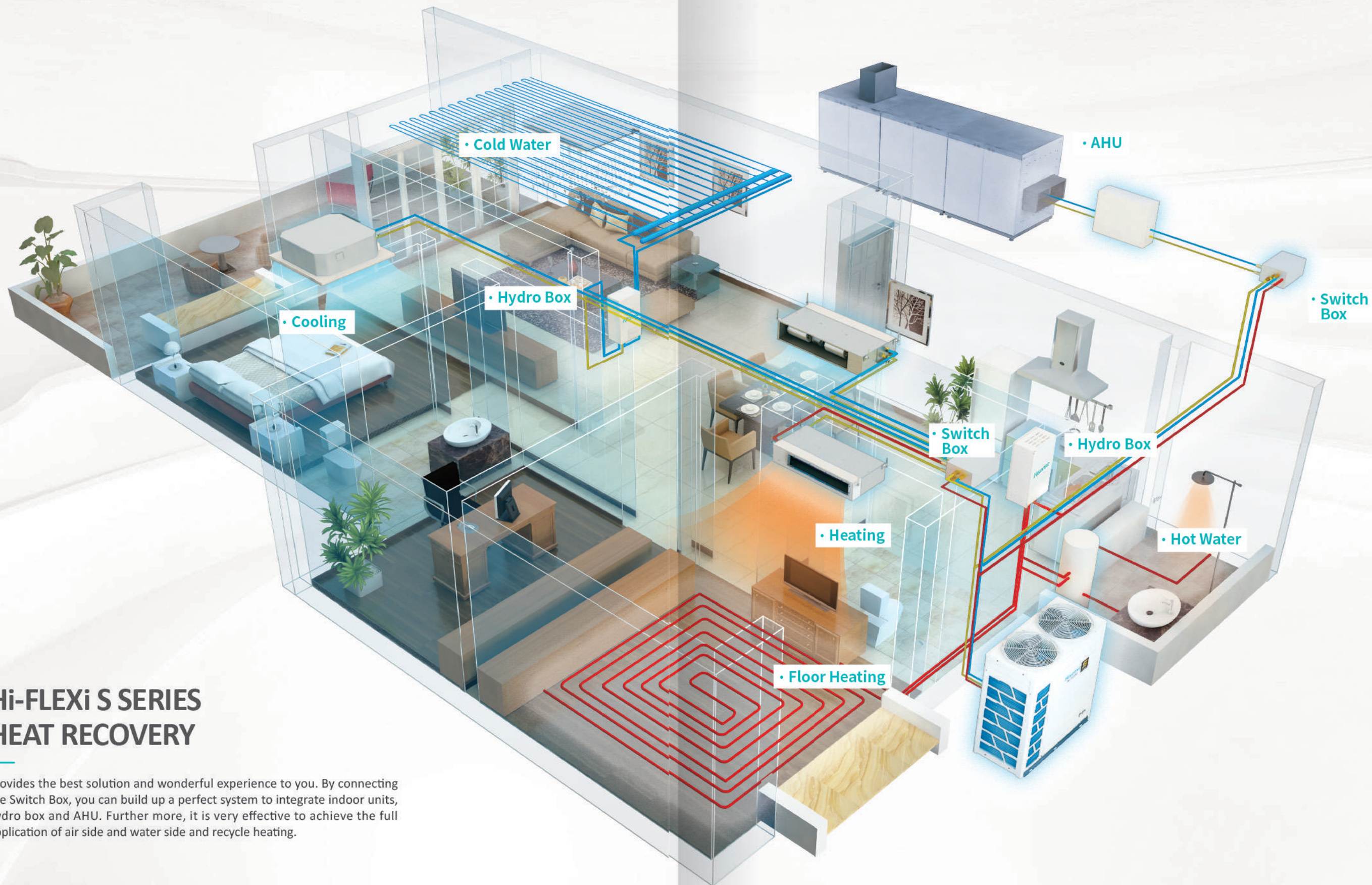

Hi-FLEXi S SERIES HEAT RECOVERY

Provides the best solution and wonderful experience to you. By connecting the Switch Box, you can build up a perfect system to integrate indoor units, hydro box and AHU. Further more, it is very effective to achieve the full application of air side and water side and recycle heating.

APPLICATION CASE

Simultaneous Cooling and Heating

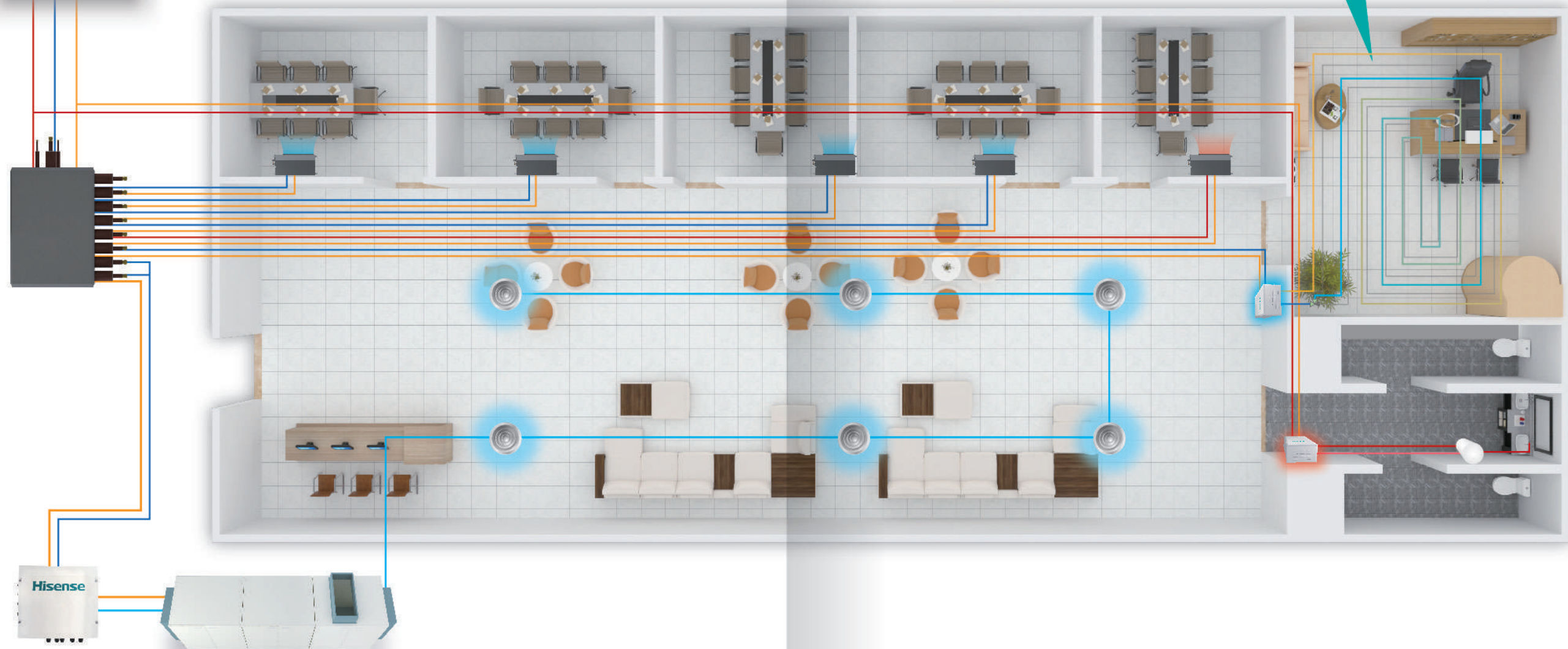
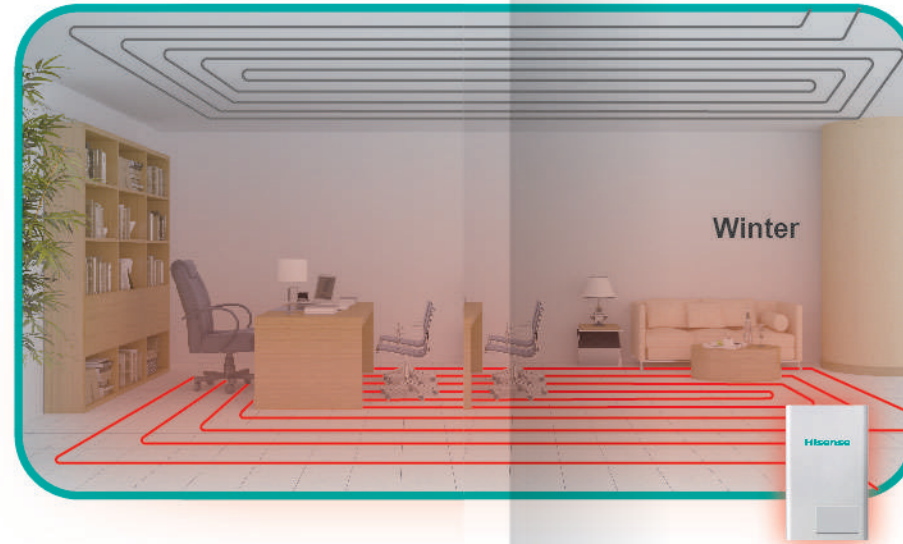

Heat Recovery Without Switch Box (Summer)

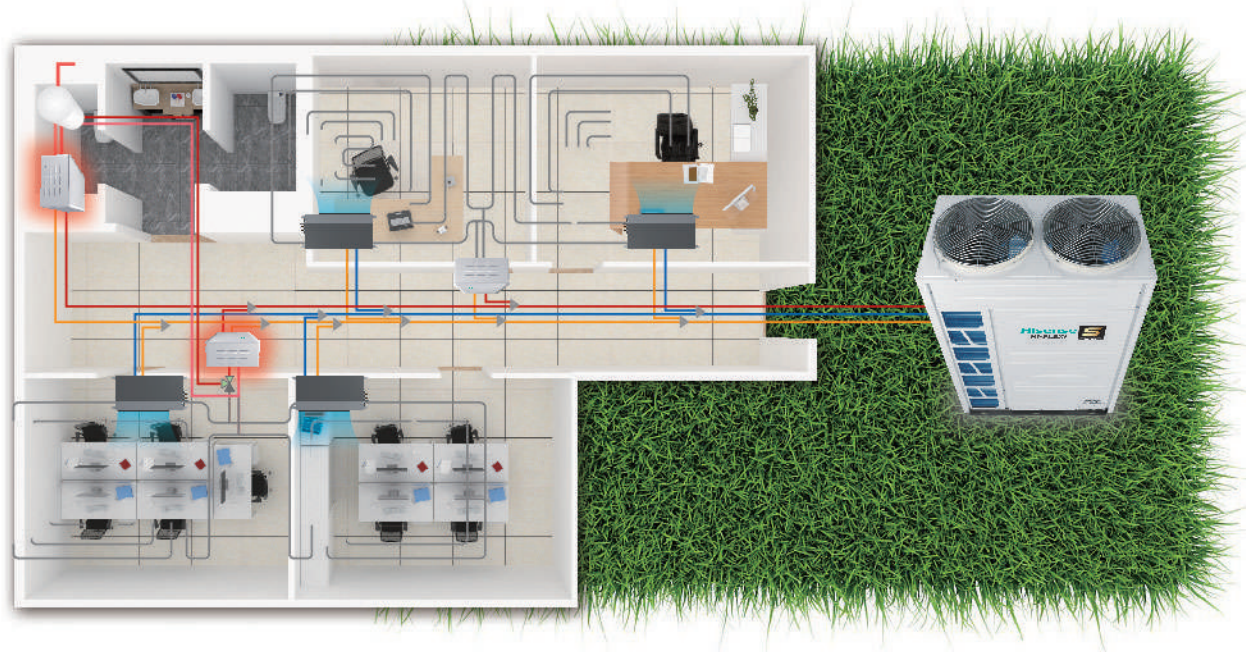

Heat Pump Mode (Summer)

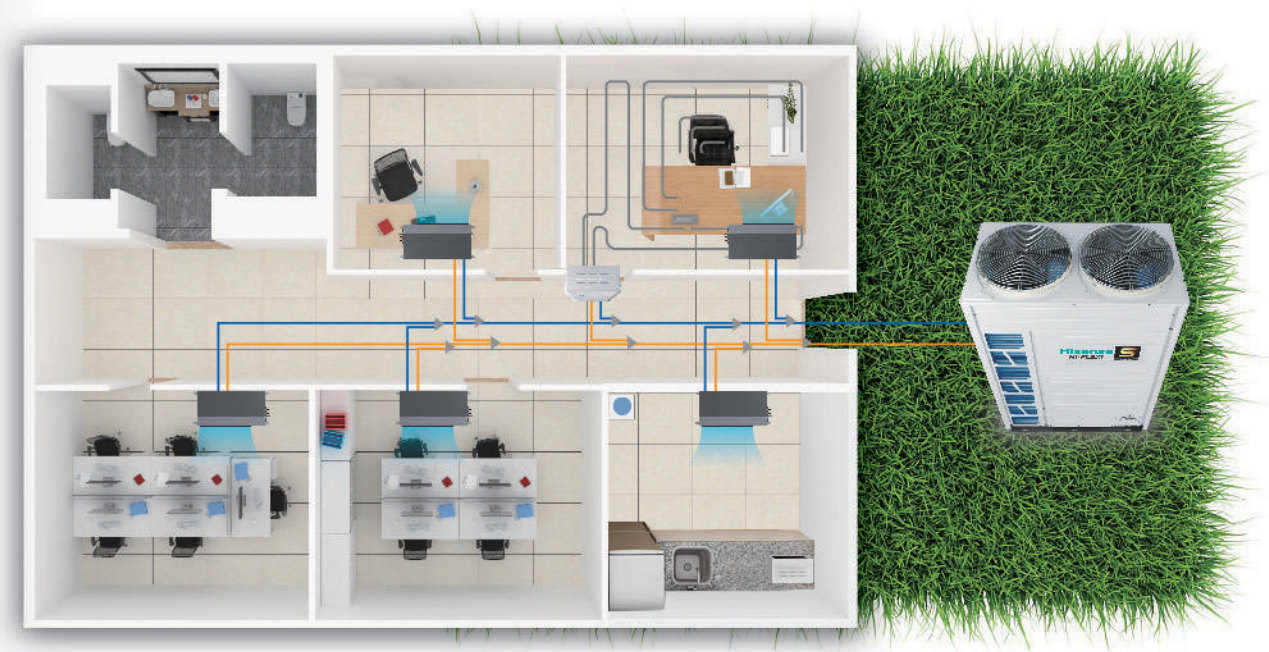

Heat Recovery Without Switch Box (Winter)

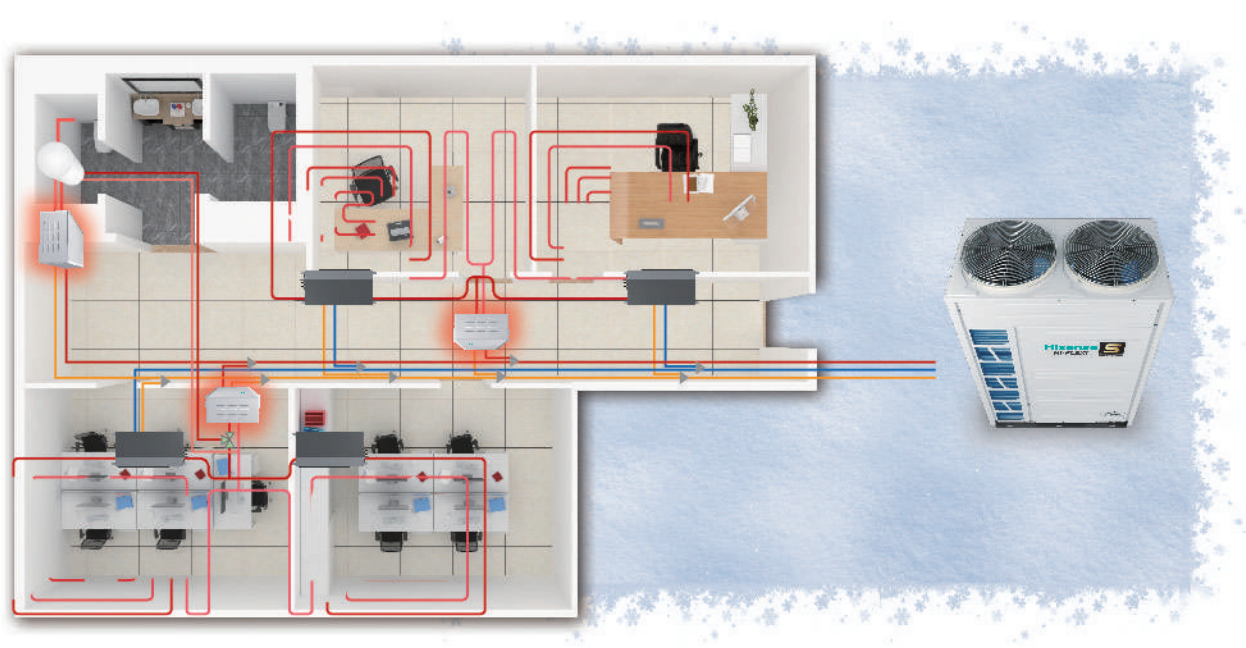

Heat Pump Mode (Winter)

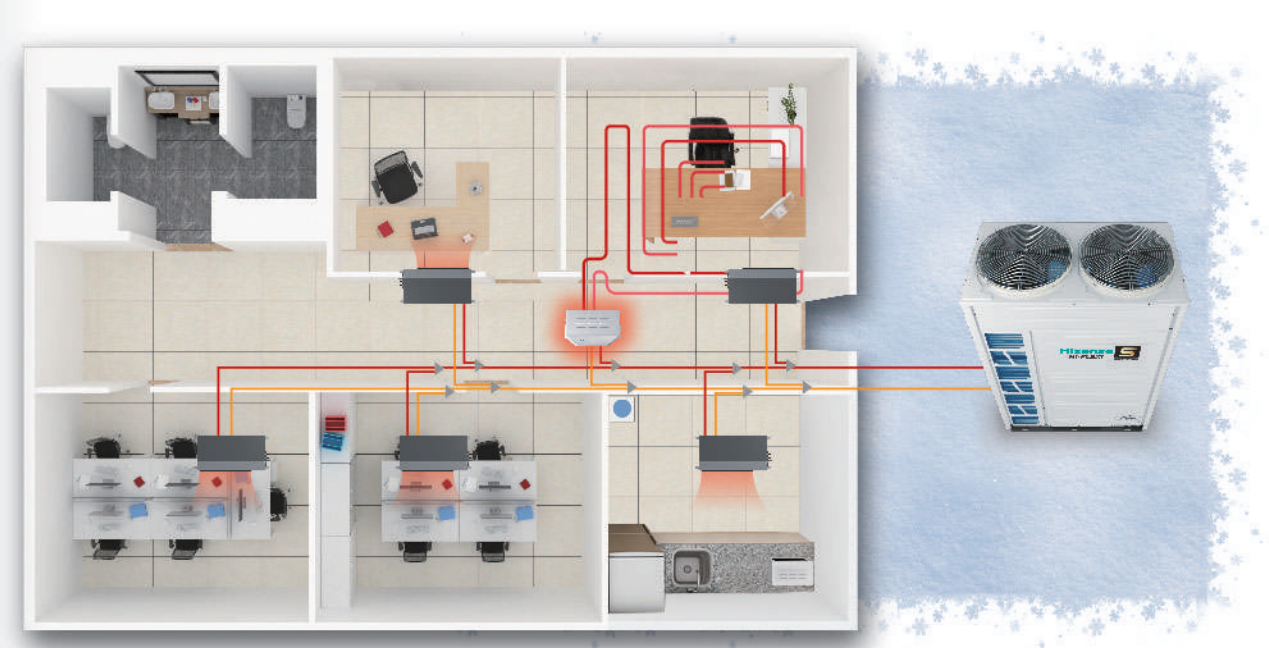

ENERGY SAVING BACKGROUND

Energy conservation is unquestionably of great importance to all of us, since we rely on energy for everything we do every single day. Today, energy conservation has become a topic that can not be ignored today by putting more effort for greener future. So everyone should have a responsibility to reuse the energy as much as possible.



WHY CHOOSE HEAT RECOVERY

In building, lots of energy run off everyday. With the rapid development of economy, it has been becoming more and more important to consider how to strengthen VRF technology research and reduce the energy consumption. Based on these reasons, Hi-FLEXI S Series Heat Recovery comes into being.

The S Heat Recovery system makes full use of waste heat from operational air conditioner that recovering the heat energy minimizing consuming electricity or external energies to achieve the purpose of energy saving. In addition, there is no time or space limit to supply free hot water. Recovering heat from VRF for supplying hot water achieves remarkable economy and is able to save energy as well as reducing thermal pollution to environment.

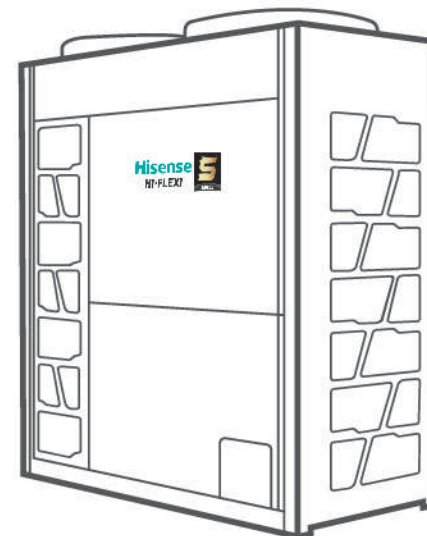

NEW ADVANTAGE

Heat Recovery Mode

Under cooling operation in summer, the heat discharged from outdoor unit can be recovered directly and used for free hot water, allowing you to enjoy free and convenient hot water supply.

Power consumption analysis

When the heat recovery mode is running, the hot water is produced without consuming additional power.

Power Consumption Index

Heat Pump Mode

When the hot water needed is below 55°C, it can be heated using Air to Water Heat Pump, saving more than 60% of electricity than direct electric heating.

Power consumption analysis

When the system is heat pump and use it to heat water, power consumption is about 33% of the heating required.

Power Consumption Index

Electric Heating Mode

When the hot water needed is higher than 55°C, the energy-efficient heat pump can heat water to 55°C. Then auxiliary electric heater will be used to heat the water to a higher temperature of 75°C.

Power consumption analysis

When the water is heated by electricity, all energies will be used and not recovered. The electricity consumption is equivalent to heat energy used (100%) without energy loss.

Power Consumption Index

New Appearance



HIGH RELIABILITY

Hi-FLEXi S Series Heat Recovery upgrades new technologies. Not only 360° fitted refrigerant cooling technology which optimizes new and whole heat sink, but also black fin (optional) carries out the overall protection, extending units' life. The comprehensive and best technologies maintain system stability and reliability.

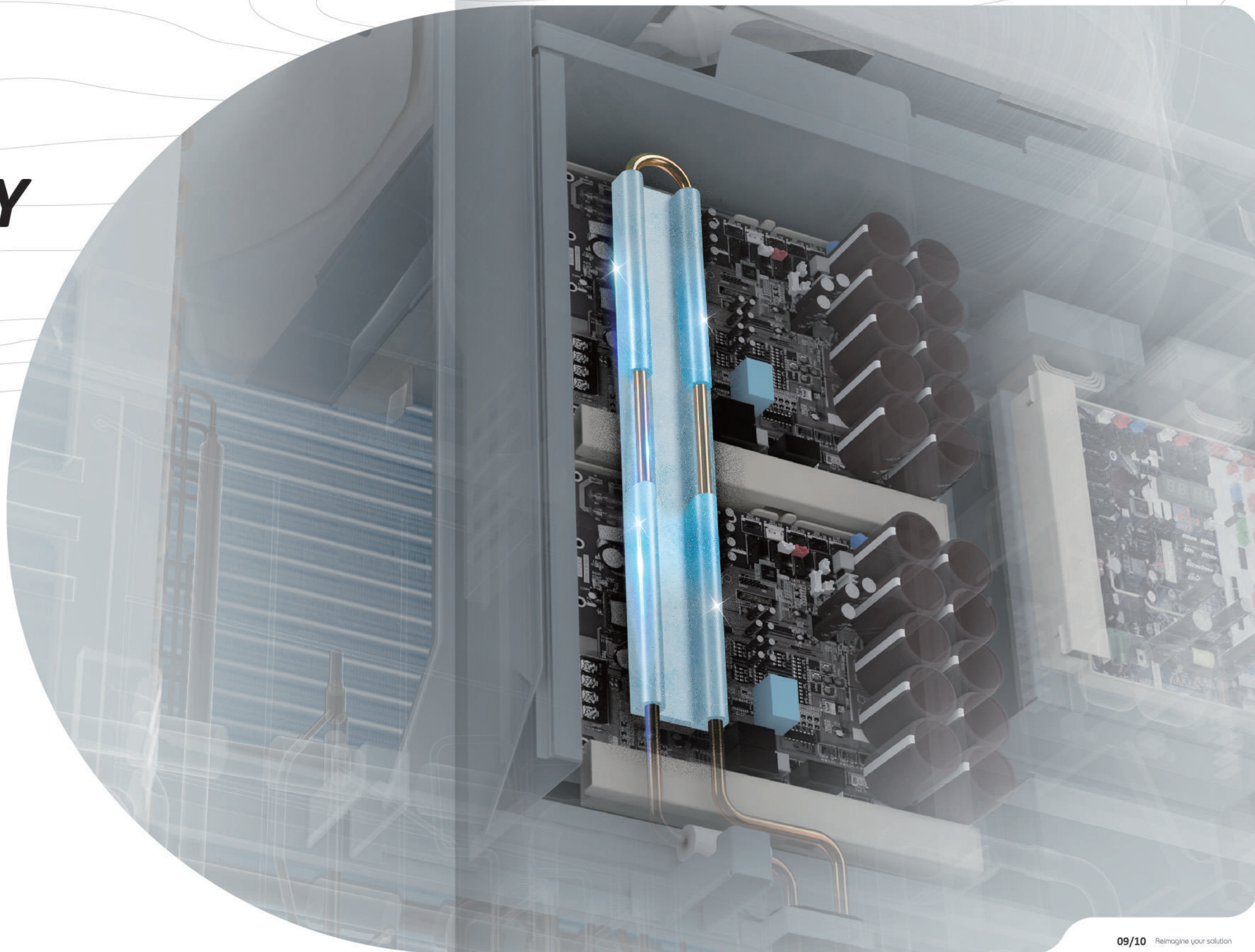

HIGH RELIABILITY

360° fitted refrigerant cooling technology

With the 360° refrigerant cooling technology, Hi-FLEXI S Series Heat Recovery will remove the heat from the main PCB, inverter module and outdoor unit's electrical box stably and efficiently. New and integral heat sink can help to improve the electrical reliability of the unit

when it is running under high ambient temperature. This ensures stability and safety of the outdoor unit running and also prevents poor heat dissipation caused by the fan cycle rotation or stop mode.

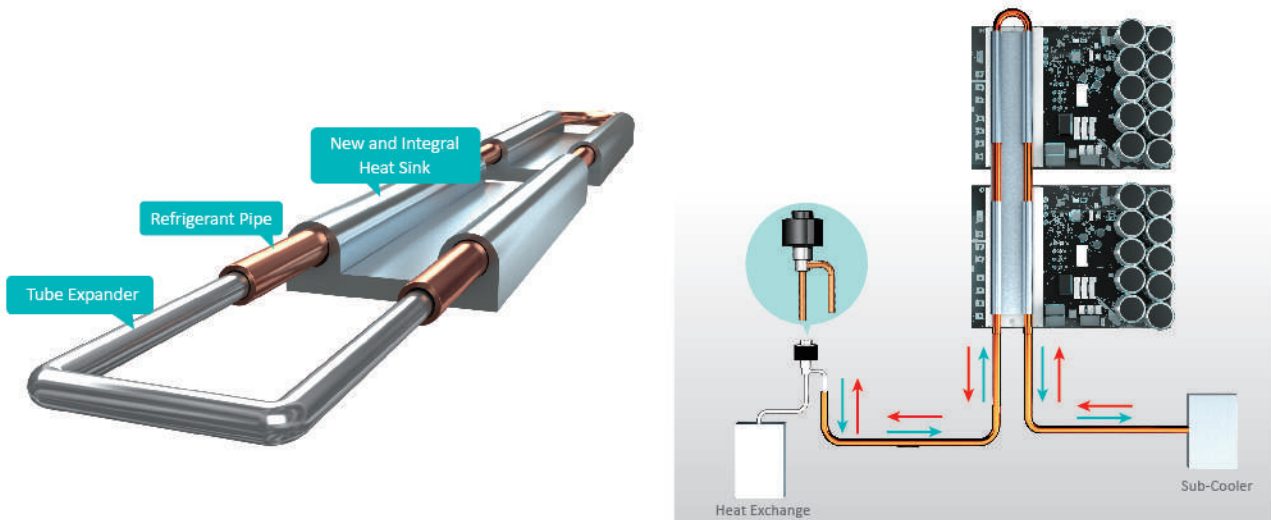

System oil cycle

The role of oil is extremely critical in maintaining the reliability and performance of compressor and hence the whole system. By recycling oil back into the com-

pressor as much as possible, the lesser maintenance and servicing is needed.

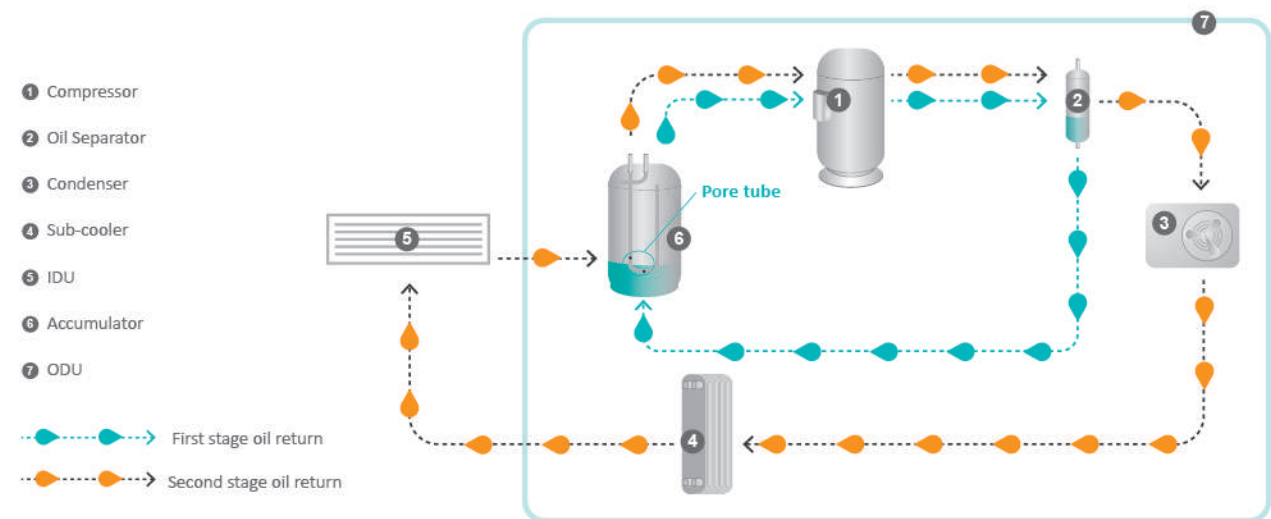

Oil retaining capability

The new compressor now has greater improvement in reliability by enhancing the oil retaining capability by 50% with an "oil cup" embedded which prevents compressor bearing to fail due to lack of oil lubricating the inner rotating component.

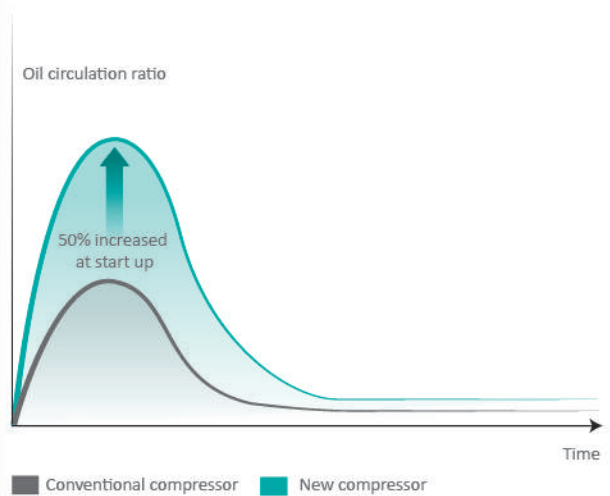

Needless of oil balancing pipes

Hence oil balancing pipes creating extra cost and hassle during installation are unnecessary. Absence of oil balancing piping system, prevents system pressure and temperature fluctuations thus maintaining overall system's continuous stability.

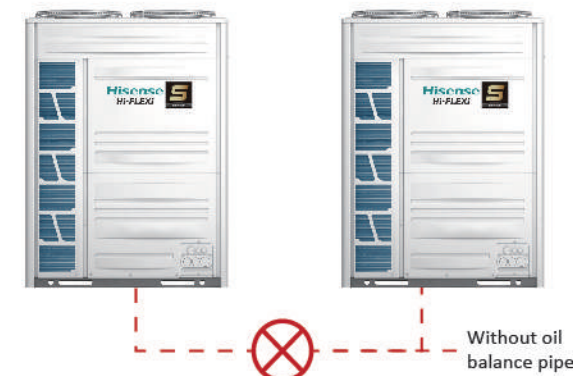

Oil separation

First-stage oil separation is realized through efficient oil separation structure inside the compressor. Only a small amount of oil is brought out of the compressor. During second-stage oil separation, the small amount

of oil discharged from compressor is separated by a large-capacity, high-efficiency centrifugal oil separator, with efficiency over 99%.

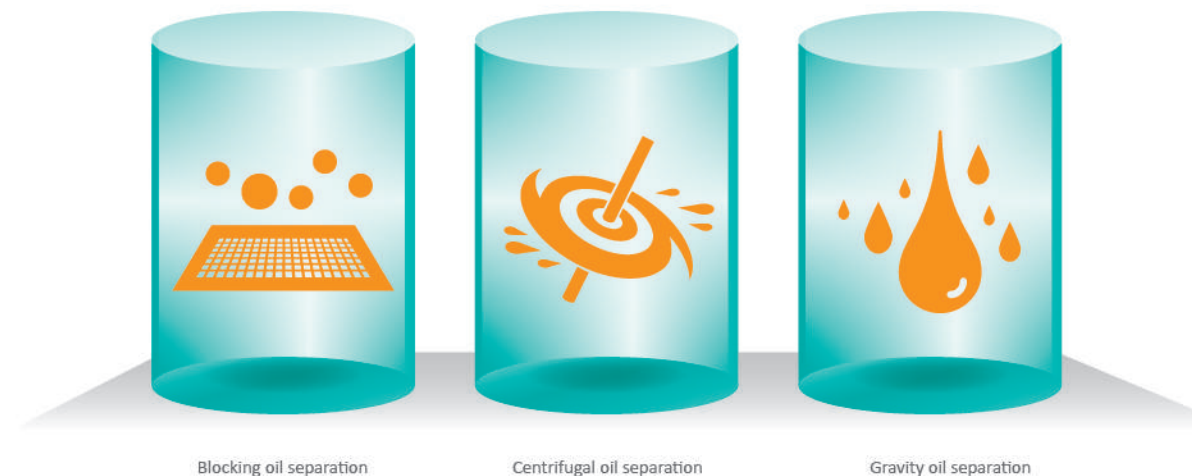

HIGH RELIABILITY

Condensate leakage protection

Besides providing reliable air-conditioning units, we also want to keep your possessions lasting. Hence, our indoor units have built-in water-leakage float switches. Alarming warnings will be displayed on controllers when condensate reaches a certain level, and would automatically turn-off itself when reaches a threatening level. Saving your ceilings and carpets from being soaked in times when drain pipes are clogged or drain pump breakdowns.

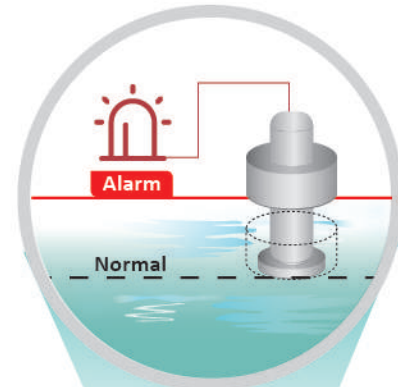

AC unit without float switch

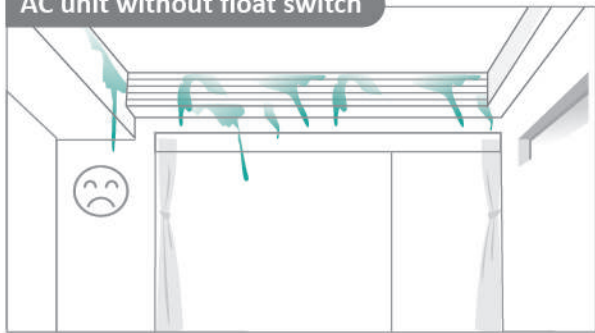

Hisense VRF

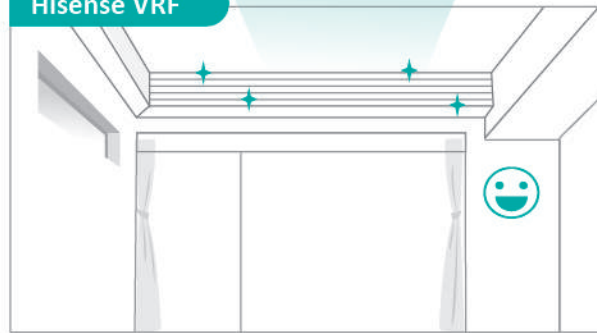

Double back-up protection

Hisense VRF has a standard double back-ups to keep you staying comfy indoors despite having a compressor or any one unit of a modular combination fails as other

compressors and units will proceed and step up its operation to ensure user's continuous comfort.



First Backup

Second Backup

Note: If you have any needs, please contact our engineers.

Smart rotative operation

Operation duties are smartly balanced in higher capacity module combinations to prevent occurrence of indi-

vidual unit overworked and hence extending the overall operating life of the overall system.

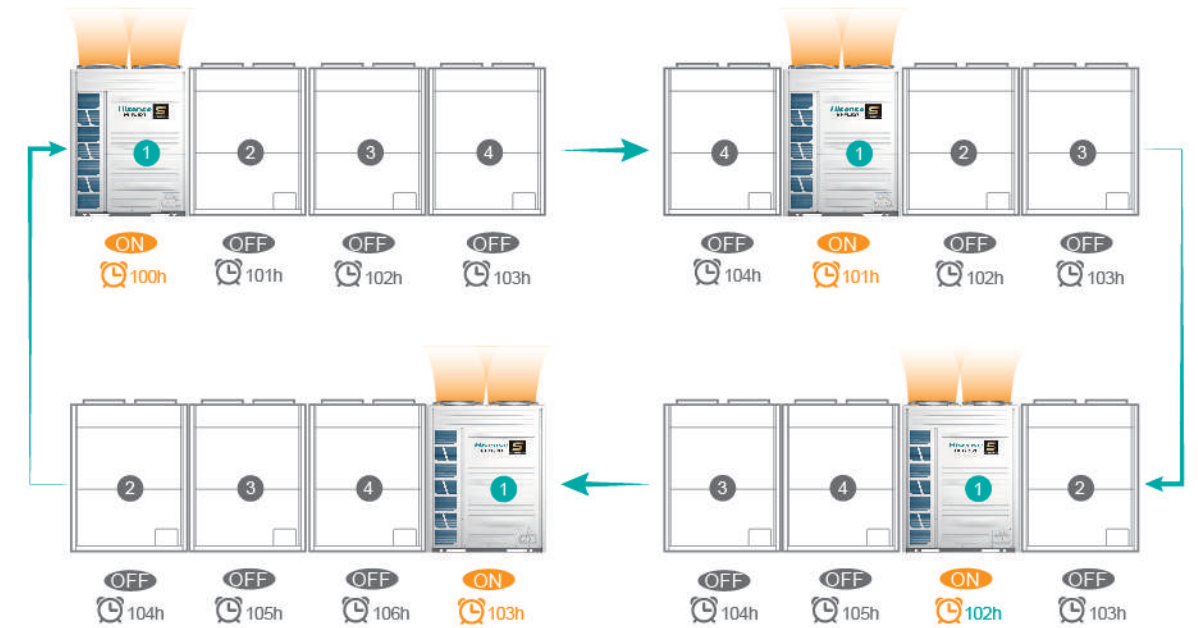

Wide operating range meets greater demand

With a wide operating temperature range, the outdoor unit can run from -25°C to 16.5°C. The heating effect in winter is strong, which perfectly meets the customers'

needs in different environment. The unit is able to run under -25°C ambient for heating mode and also able to run under 52°C for cooling mode.

Wet Bulb

Heating Mode

Dry Bulb

Cooling Mode



Note: The temperature range of dry bulb is -25°C to 26°C.

HIGH RELIABILITY

Hi black fin

Hisense anti-corrosive fins are coated with epoxy resin using film-forming techniques while the traditional resins are acrylic resins. The epoxy resin is 1.5 times

thicker than acrylic resin, and its acid-resistant, alkali-resistant and salt-fog resistant properties is 3 times better than acrylic resin.

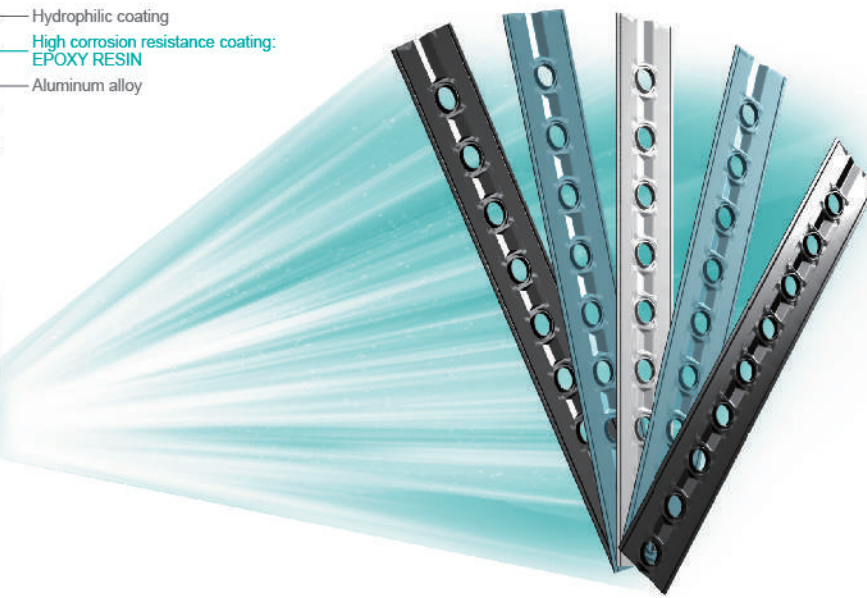
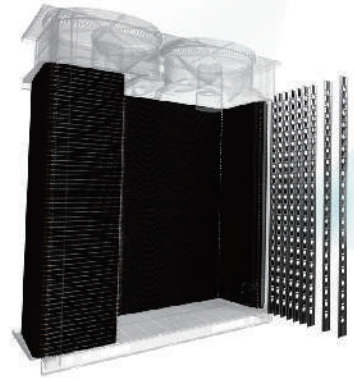

Anti-corrosion solution

Hisense's complete corrosion-proof solution is your perfect choice when it comes to seaside and chemical factory applications, providing ultimate comfort without sacrificing life span and lowers maintenance cost

simultaneously. Besides the heat exchanger, components from top to toe are treated with effective treatments and tested according to ISO, ASTM and GB standards.

- 1 Front Panel
- 2 Heat Exchanger
- 3 Electrical Box
- 4 Fan Motor
- 5 Top Grill
- 6 Motor Bracket
- 7 Protection Net
- 8 Pressure Vessel

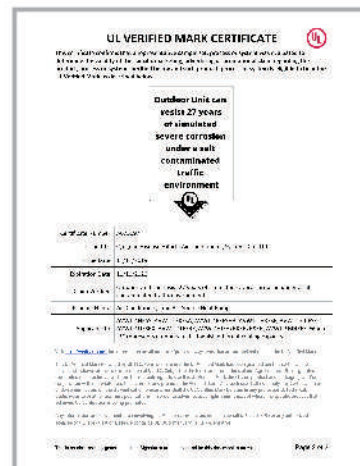

Self-protection

Taking a step further, Hisense VRF is capable of keeping themselves protected with algorithms embedded to make necessary protective decisions and measures based on different sensor readings & parameters.

Including compressor protections, heat and temperature protections, over and under pressure protections and electricity protections.

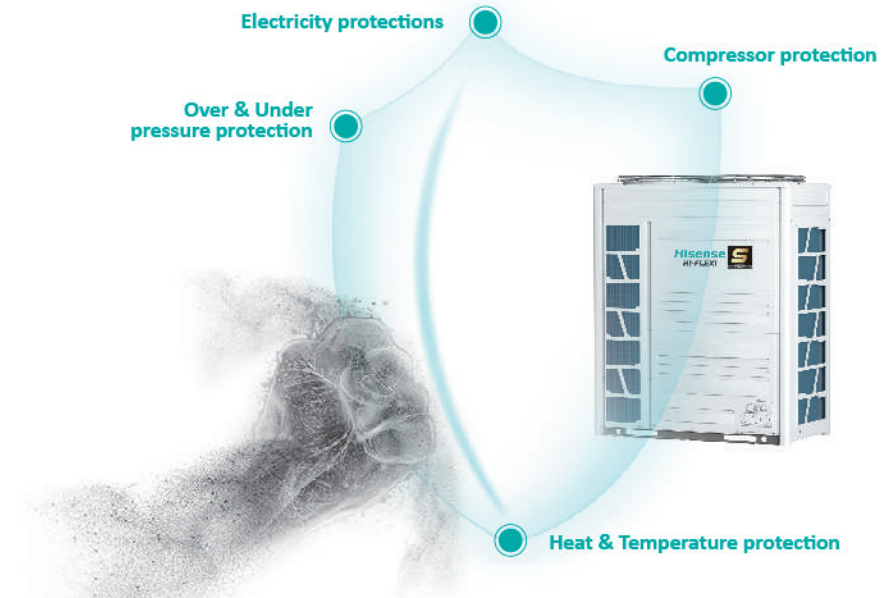

Electro-magnetic protection

Air-conditioning units produced by Hisense VRF requires strict electromagnetic protection. As to overcome such inevitable natural phenomenon to

cause damages, 4000V sudden high voltage tests are infused into the long list of electromagnetism quality tests in our internationally qualified test laboratories.



HIGH EFFICIENCY

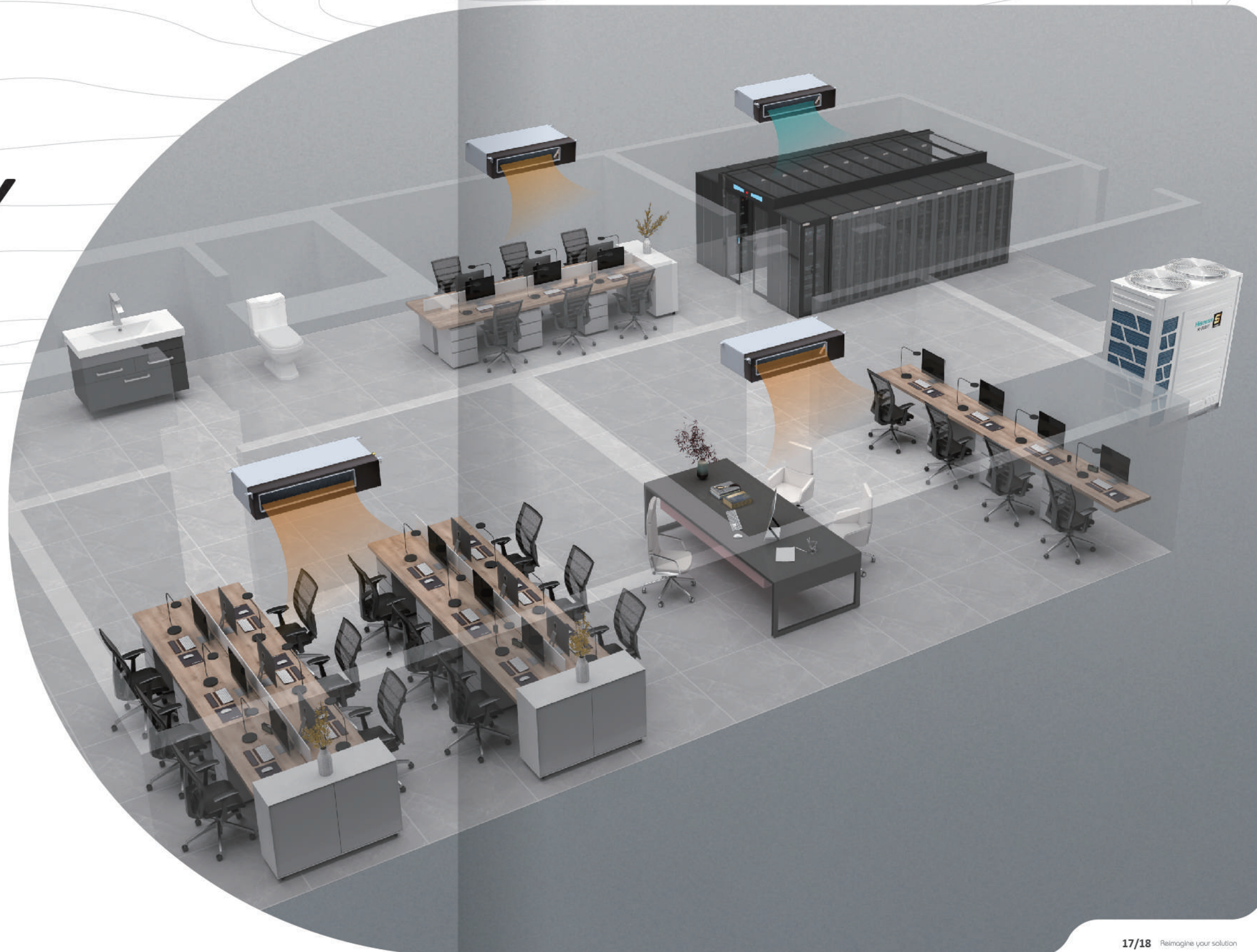

Air conditioning system takes up approximately 40~60% of the total energy consumption in a building. Hi-FLEXI S Series Heat Recovery realizes simultaneous cooling and heating from one system to save energy. Therefore, it has important and profound social meaning.

HIGH EFFICIENCY

Generation of enhanced vapor injection scroll compressor

Hi-FLEXI S Series Heat Recovery adopts a new generation of the high efficiency scroll compressor with patented vapor injection technology. It can greatly enhance the heating performance and achieve high

energy-saving efficiency. Powerful heating is guaranteed by Hi-FLEXI S Series Heat Recovery, especially under low temperature with heating performance increased by 25%, compared with the standard model.

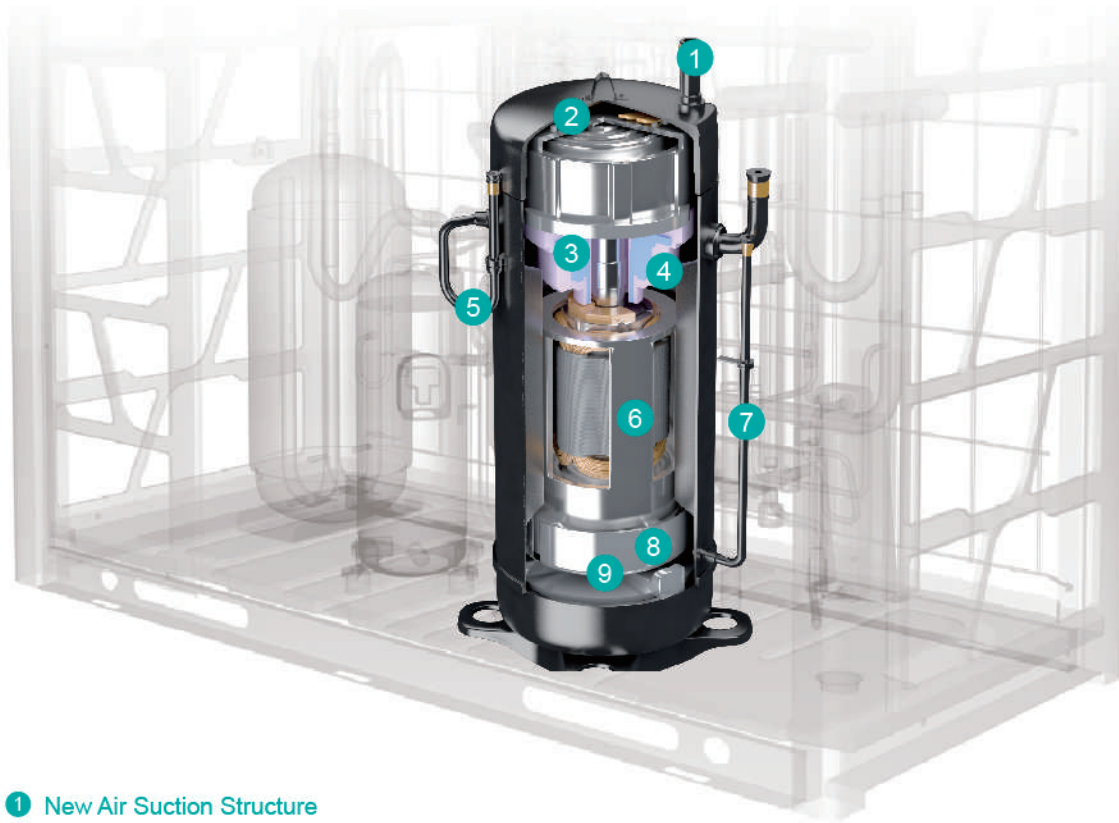

1 New Air Suction Structure

Improve compressor efficiency under fast rotation speed condition, increase compressor stability under strong load mode.

2 Overpressure Releasing Valve

Increase efficiency by reducing compression loss, especially for medium and low capacity conditions.

3 Driven-frame Structure

High performance technology by reducing leakage loss and friction loss.

4 Special Exhaust System

Minimum oil loss and saving oil within the compressor.

5 Vapor Injection Design

6 High-efficiency Motor

High efficiency by rare earth magnet and special designed motor.

7 Oil-balance Pipe

Improve units reliability.

8 Oil-separation Structure

High reliability by keeping oil in the compressor by this separation plate.

9 PVE Oil

Using PVE oil ensuring a high reliable and long life.

Efficient energy usage

Wasted power is reduced by minimizing leakage and overcompression while compressing refrigerant gas with asymmetric scroll and patented release valves.

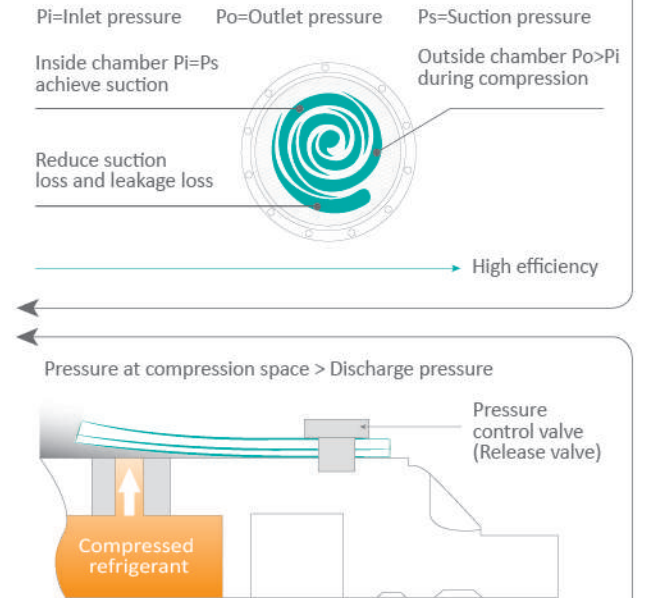
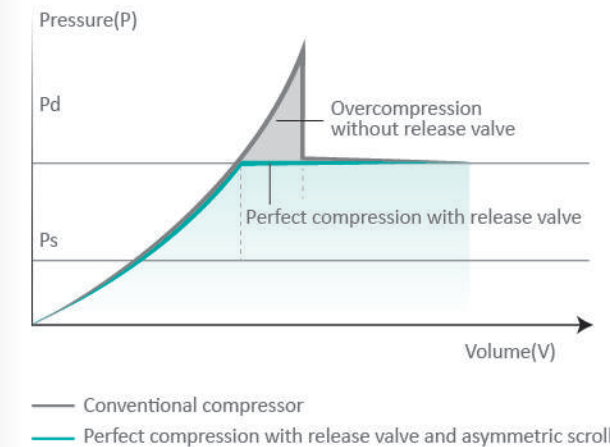

New advanced wavy fin design

A new commitment is made on new fin design to create better efficiency and more durable heat exchanger. With this new design, larger amount of fins can be allocated into the heat exchanger, increasing 22% heat exchange surface area.

As to improve heating capability, the new design fins are 40% more tolerant to frost, stretching out indoor heating time interval and further enhancing user's coziness. Heating time interval are tested to reach 50% increment compare to previous models.

Features and Benefit		
Air Flow Resistance	Decreased 20%	↓
Total Heat Transfer Area	Improved 21.4%	↑
Heating Capacity Without Frost (Test Condition 7°C DB / 6°C WB)	Improved 1-3%	↑
Heating Capacity When Frosting (Test Condition 2°C DB / 1°C WB)	Improved 8-12%	↑
Ability to Resist Frost	Improved 40%	↑
Anti-corrosion Ability		↑

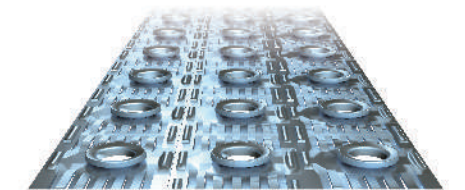

Stepped fins



Latest wavy fins

HIGH EFFICIENCY

Two-stage sub-cooling technology

The cooling section of the outdoor heat exchanger is uniquely designed to be more effective than the traditional outdoor units of the multi-split air conditioner without a sub-cooling design. First-stage sub-cooling

can reduce temperature by 12.5°C while second-stage sub-cooling can help achieve up to 27°C for efficient sub-cooling.

Two-stage Sub-cooling Cycle Diagram

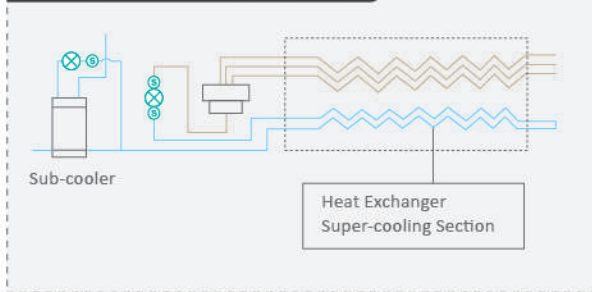

Two-stage Sub-cooling Pressure Enthalpy Diagram

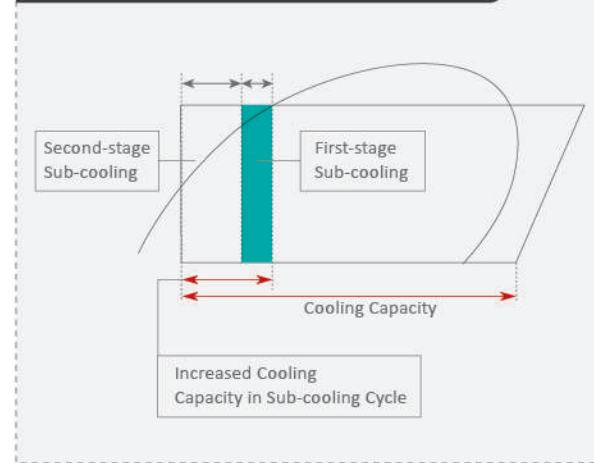

- ⊕ Increasing cooling capacity of the unit refrigerant
- ⊕ Reducing the resistance when refrigerant flowing in pipelines
- ⊕ Increasing sub-cooling degree, more accurate controlling of electronic expansion valve, more stable operation
- ⊕ Increasing sub-cooling degree, increasing the length of refrigerant pipe

Optimized refrigerant circuit

As refrigerant flows in the system, energy will be lost due to friction and other factors naturally especially when refrigerant change phase, latent heat are lost when gas turns to liquid. Whereby, as more heat is dissipated out, higher the heat exchanger efficiency is.

By making full use of heat dissipation, refrigerant flow layout is maneuvered into 2 to 1 Refrigerant Flow Path extends liquid refrigerant's occupancy and eventually the efficiency too.

2-to-1 refrigerant flow path

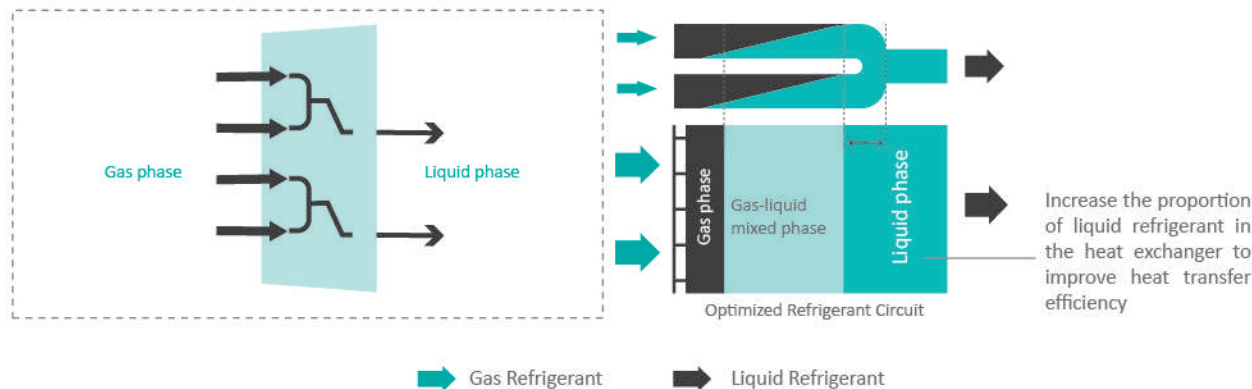

Hisense refrigerant temperature control

- 1) Evaporating temperature can be adjusted between 2°C to 16°C which is the widest on the market.
- 2) Rapidly cooling depends on the lower evaporating temperature.
- 3) Preventing cold draft bases on the higher evaporating temperatures.
- 4) Saving energy by increasing seasonal efficiency. Features:

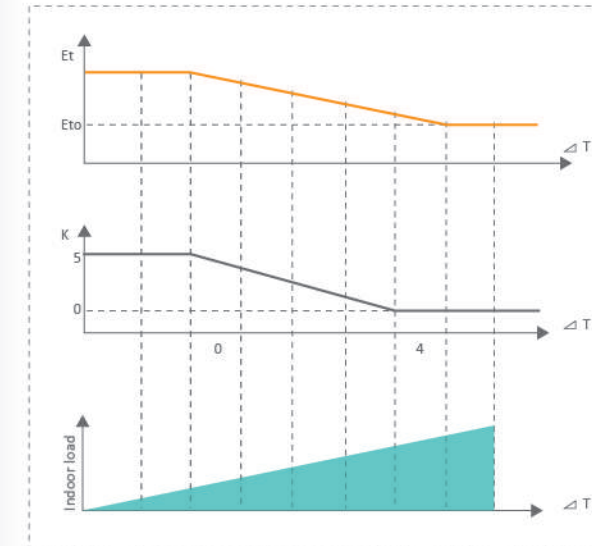

High efficiency aerodynamic axial fan

Fan blades are aerodynamically designed to reduce energy wastage in converting power consumed to unnecessary noise energy, reserving the energy to improve on flowrate performance and static pressure. Integration with brushless DC fan motor further improves the efficiency and noise of the propeller structure.

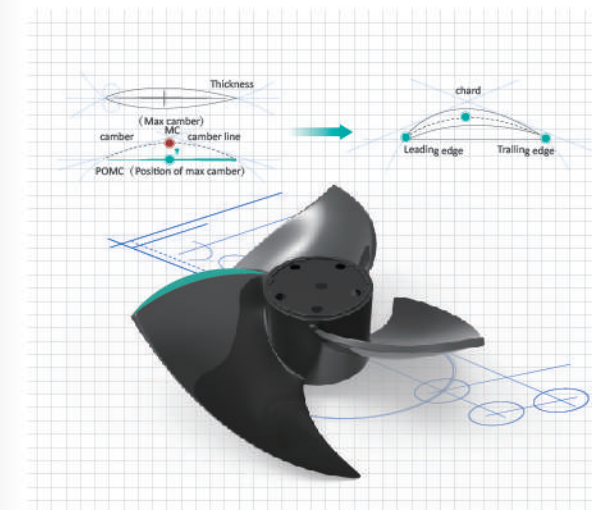

Demand mode

The intelligent demand mode can adjust the air conditioning automatically according to peak-valley requirements of electricity. It achieves balance between comfort and energy-saving while meeting the power demand for daily work.

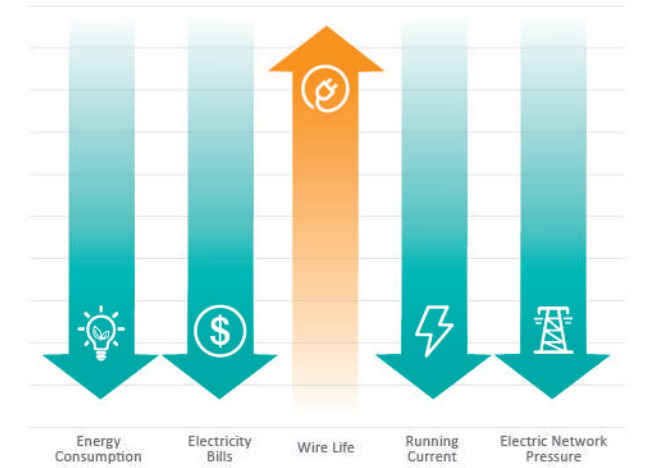

COMFORT

A high standard quality of life is living in ultimate comfort. Hi-FLEXi S Series Heat Recovery can adjust indoor units temperature within $\pm 0.5^{\circ}\text{C}$ to ensure less fluctuation. Hisense pays attention to preferring user experience. Users' comfortable experience is Hisense's priority. Hence, Hisense wishes to supply the most optimal temperature, humidity and air quality.

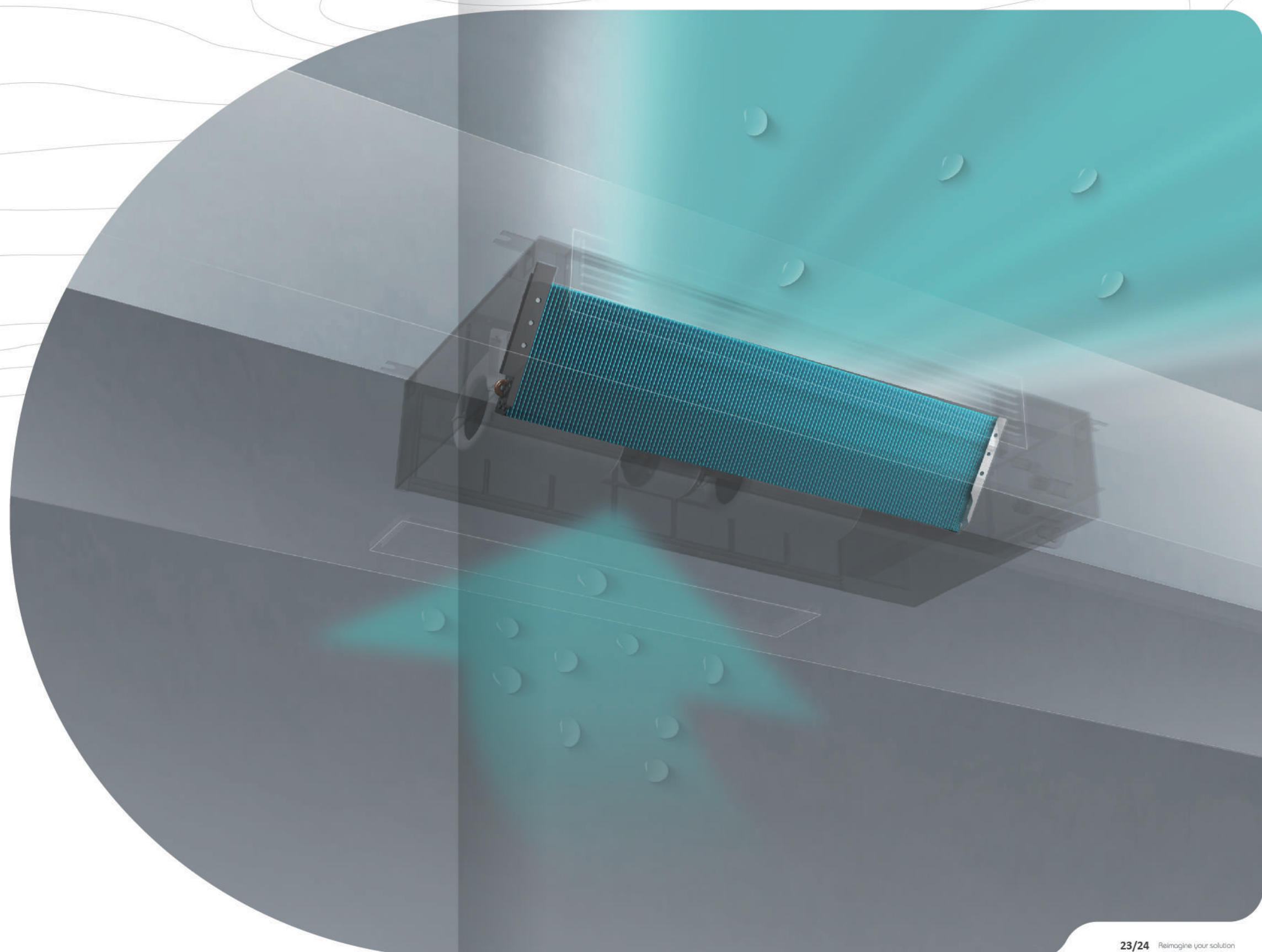

COMFORT

Consecutive heating

Hi-FLEXi S Series Heat Recovery can achieve only one module defrosted at a time. The indoor units temperature have less fluctuation. So it can ensure continuous comfort during the whole heating.

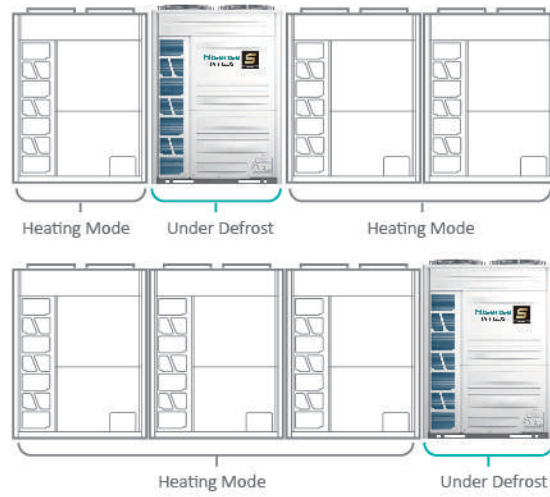
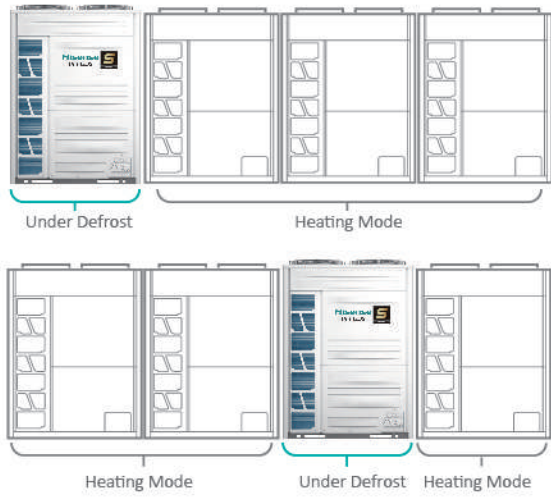
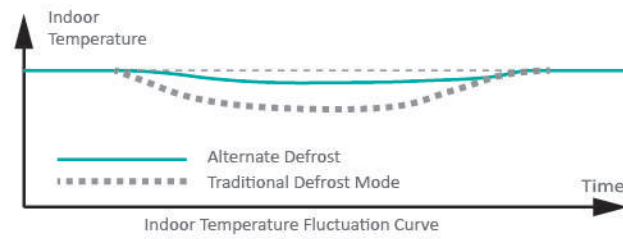

Hydro box defrost

Hi-FLEXi S Series Heat Recovery can choose hydro box defrost. There is no doubt that room temperature will be less fluctuation to keep comfort.



PTT defrosting mode

During cold freezing days where temperature is low and humid, water vapour in the air would solidifies into frost shandiao. As frosts pile up on the heat exchanger of an outdoor unit, it would need to be liquified and

removed. An Intelligent Defrosting Logic could determine the perfect timing to defrost, saving unnecessary energy usage compare to conventional defrost measures, maximizing users' comfort indoors.

Hisense's Optimal Defrosting Mode

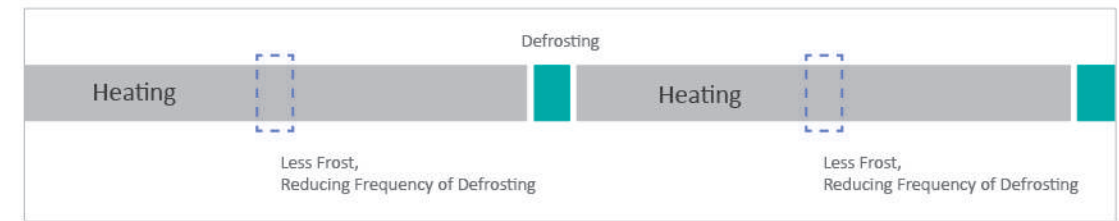

Traditional Defrosting Mode

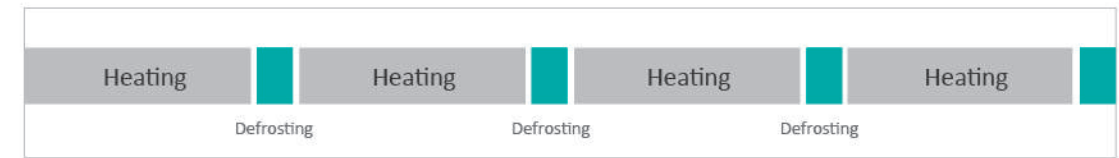

Bottom anti-frosting structure

To ensure effective frost removal, heat exchanger circuit is extended to the bottom to make sure melted frost from the top does not solidify as it reaches to the condensate drain and hence enhances smooth discharge. In the meantime, the heat also extends frost formation periods whereby prolongs defrost interval.

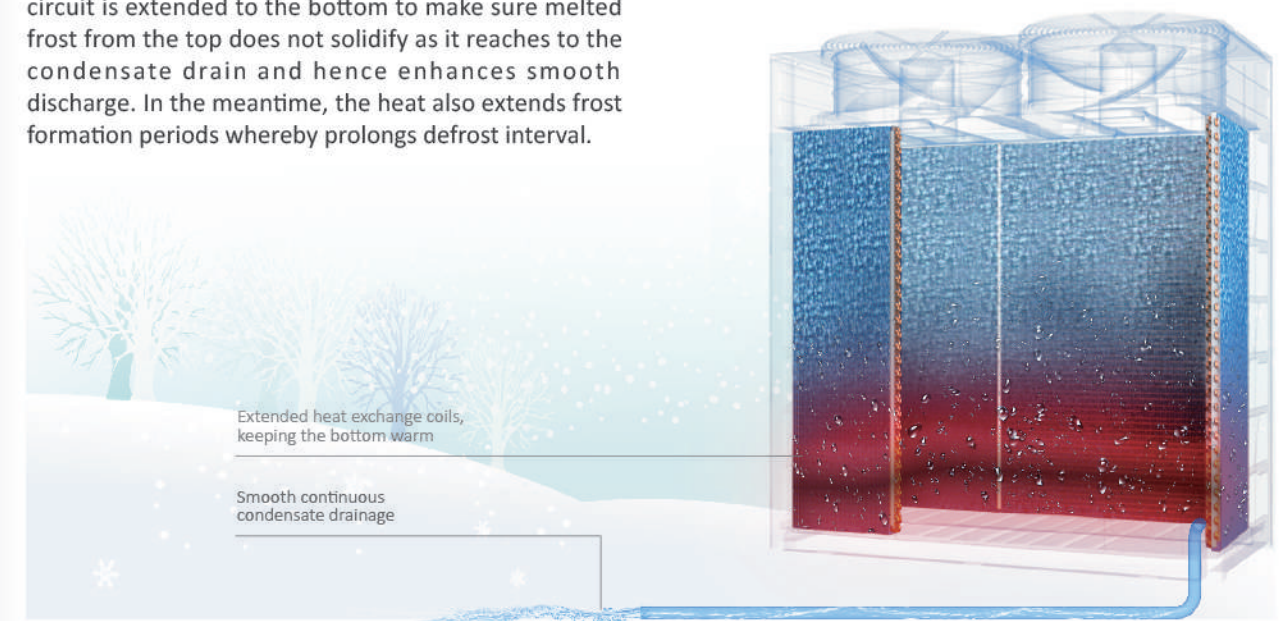

COMFORT

Dual 20RT EEV

The 20RT EEV with 3000 steps extends the controlling range. Upgrading 10RT to 20RT and changing 480 steps

to 3000 steps, its precision is improved. Also the new design can reduce pressure loss of heat exchange.

Before

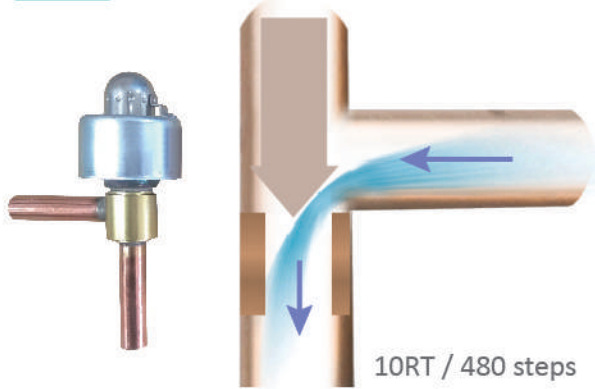

10RT / 480 steps

New

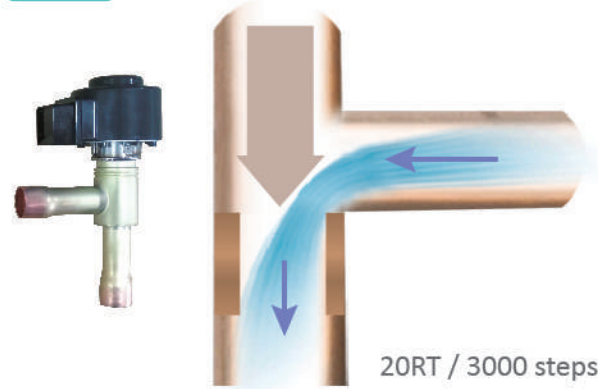

20RT / 3000 steps

90s rapid heating start-up

Cold freezing days are sometimes so difficult to bare with, especially after a day out under the crisp frosty air. To keep you comfortable and cozy as fast as possible, Hisense VRF starts supplying warm air so rapidly

with only just 90s reaching a 100% capacity output. A total of 30% improvement from our old models which requires 120s.

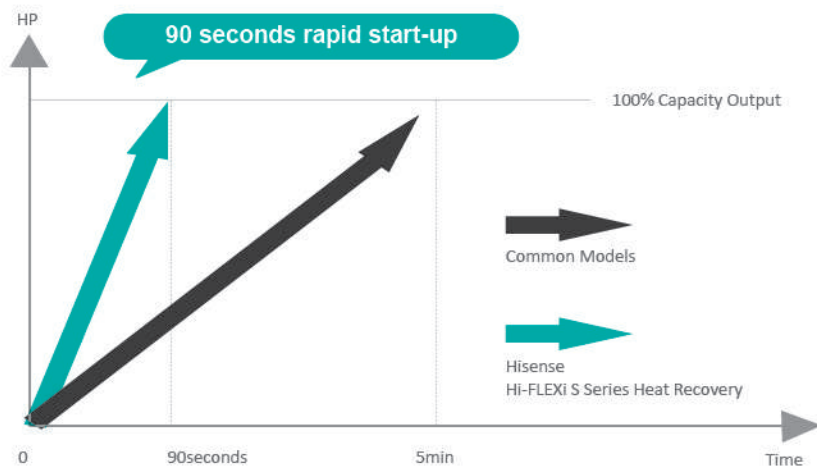

*Taking 66HP as an example



Lower noise

Noises are often a pain in the neck, especially when we're trying to put our mind into something. Working, studying even exercising and relaxing needs concentration. Hisense VRF offers indoor units with sound pres-

sure level as low as 21dB(A). Perfectly blends into library, auditoriums and hospital rooms where requires sound levels lower than 25dB(A).

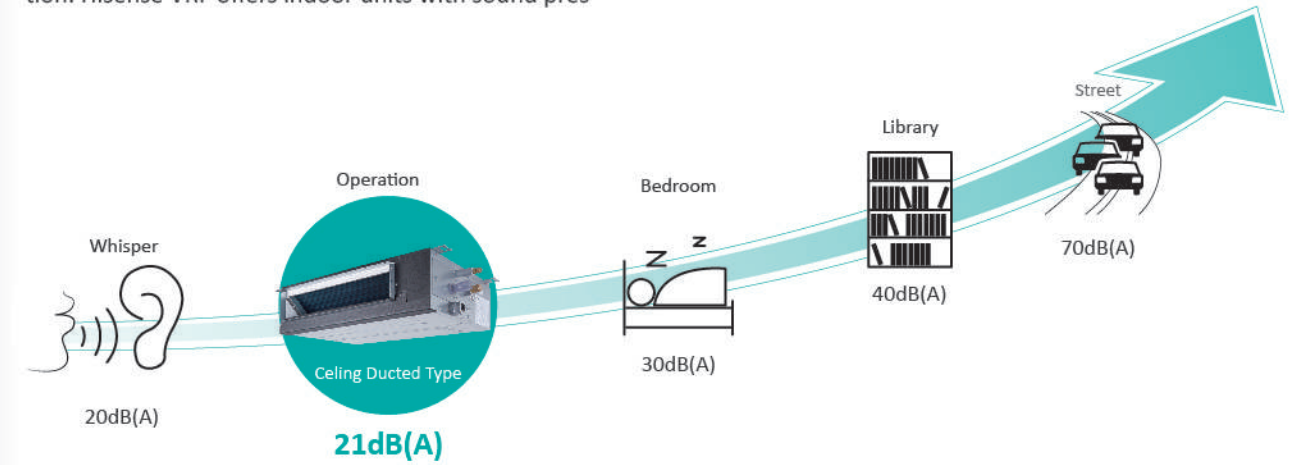

Note: The data was measured in an anechoic chamber, only the DC ceiling ducted type (AVE-05HJFDL) in low noise mode achieves 21dB.

Night mode

When outdoor conditions call for special low noise requirements, like in cases where outdoor units are installed in indoor equipment rooms with poor sound-proof walls or continuous night operating conditions.

Fear not, we've got you covered with our night mode to reduce sound pressure levels upto 30% routinely with flexible time intervals to meet different customer needs.

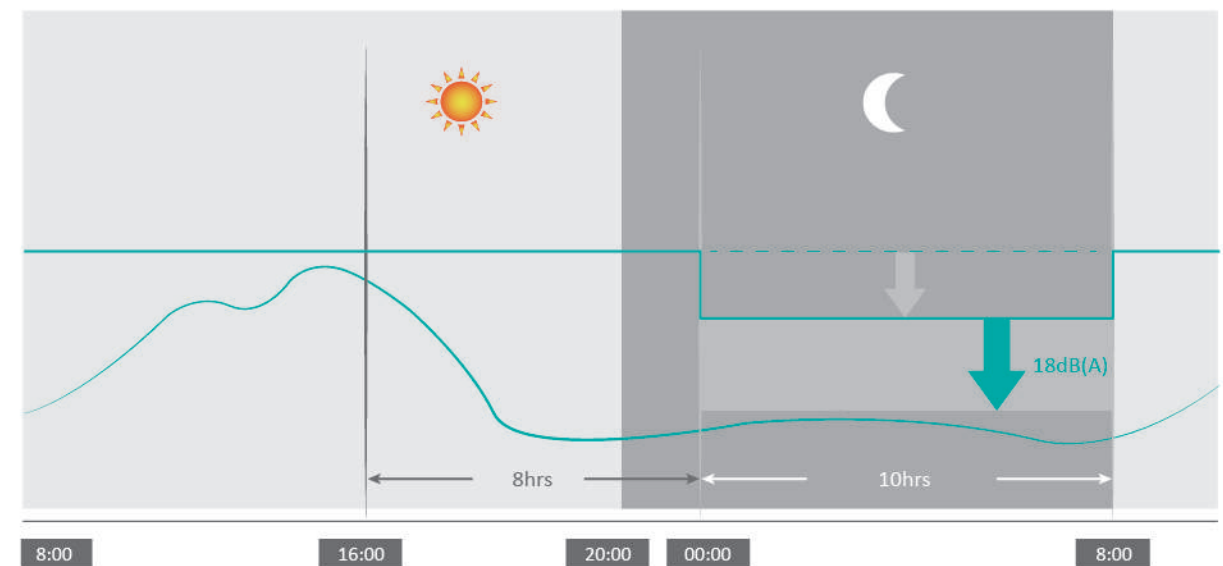

COMFORT

Precise temperature control

Hisense VRF provides very close tolerance of temperature in the range of $\pm 0.5^{\circ}\text{C}$, reduces temperature fluctuation and effectively maintains the desired temperature.

- Precisely judge indoor temperature:
- (1) Air return temperature sensor
 - (2) Temperature sensor on wired remote controller
 - (3) Based on the average value suitable for irregularly shaped room

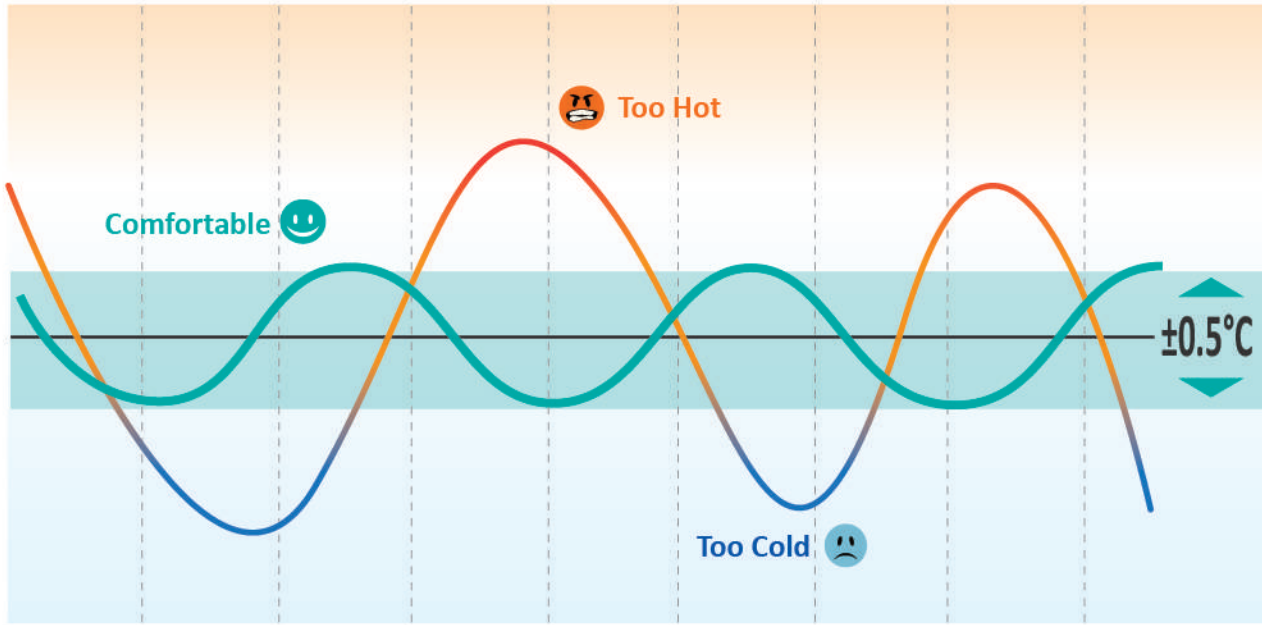

Hisense Temperature Control, Most Comfortable, Conventional Temperature Control, Setting Temperature

Precisely judge

$\pm 0.5^{\circ}\text{C}$ tolerance is made true by high quality and high precision 2000 steps electronic expansion valve (EEV) used to control refrigerant flow more precisely depending on the real-time room temperature feedbacks from temperature sensors on controllers and indoor units.

2000-step electronic expansion valve to ensure precise flow adjustment based on the actual load of Indoor Unit.



Smarter sensor - Hi-Motion

What's more comfortable than having a unit that follows you to wherever corner of the room? Hisense VRF offers more than just artificial intelligent integrated AC unit. Hi-Motion, unbeatable style with elegant white circular design. Dynamic and practical with detection capability upto 7m distance and area of 34m². Boundaryless installation including wall mounted or ceiling attached to meet any space restrictions and interior designs.

Main Functions

- High Precision**
Adjust AC temperature and air flow speed precisely according to the number of users
- Wide Range**
Sense as much as 34m² with almost no blind area
- High Energy Conservation**
Turn off AC automatically when nobody is in the room

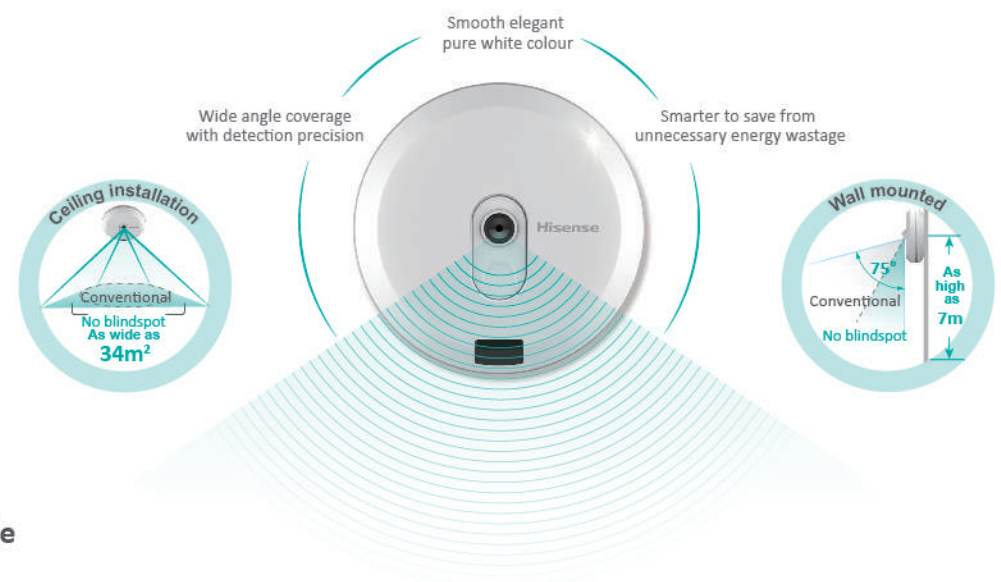

VIP mode

When there's a very important person in the house and air-conditioning priorities are needed to be given to them. Hisense VRF offers VIP modes to give priorities to the specific rooms, keeping them comfortable and

satisfied as fast as possible. Such function is exclusively practical for hotel applications, where AC units in the presidential suites are often set to VIP mode. Keeping users comfortable is our top priority.

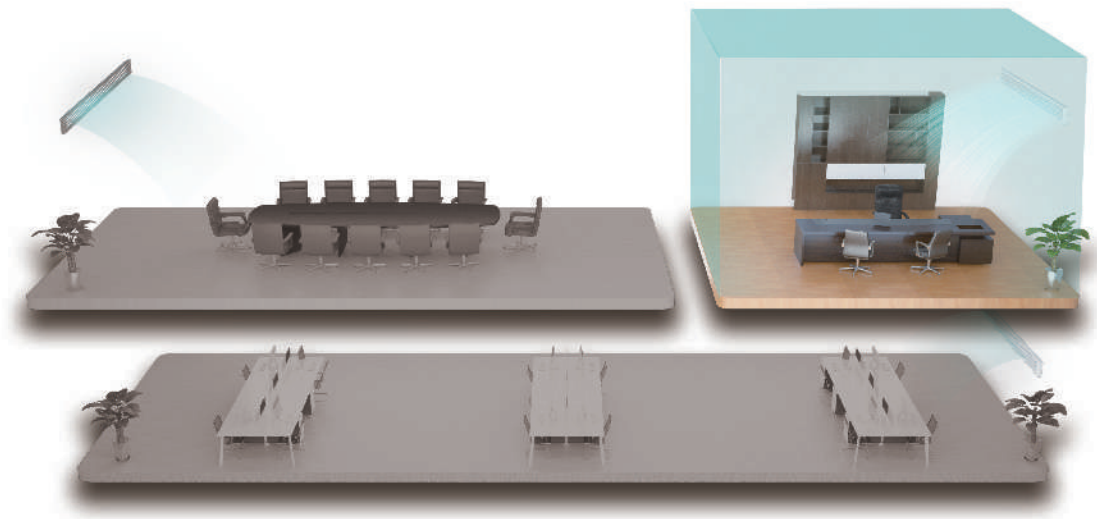

CONVENIENCE



Comparing with original heat recovery product, new S Heat Recovery extends the static pressure from 60Pa to 110Pa, which provides better conditions for installation. Also Hi-FLEXi S Series Heat Recovery can realize that the match ratio of ODU and IDUs is Max. 200%. All designs will optimize the installation and transportation of equipments.

Max.
200%

CONVENIENCE

Mistake connection

Communication line connections between ODU and IDUs might be confusing when comes to long cables from the outdoors to the indoors and vice versa. It is often incorrectly connected and caused various errors

affecting the end user's comfort levels. Despite of Hisense VRF's simple wiring connection ports, the outdoor unit itself could also check on the connections and display warnings when the connections are improper.

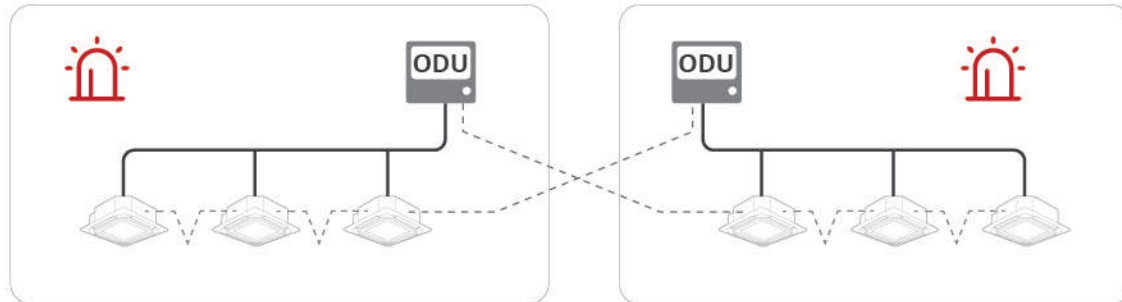

Indoor units from different systems are connected to the incorrect outdoor unit, alarm codes flashes out warning installers to make proper corrections.

Indoor unit dry contact interface

In the indoor unit, ports are reserved for wider choice range of applications to turn the AC unit ON or OFF, like

key-card power, window contact power and any other third party sensors or devices.

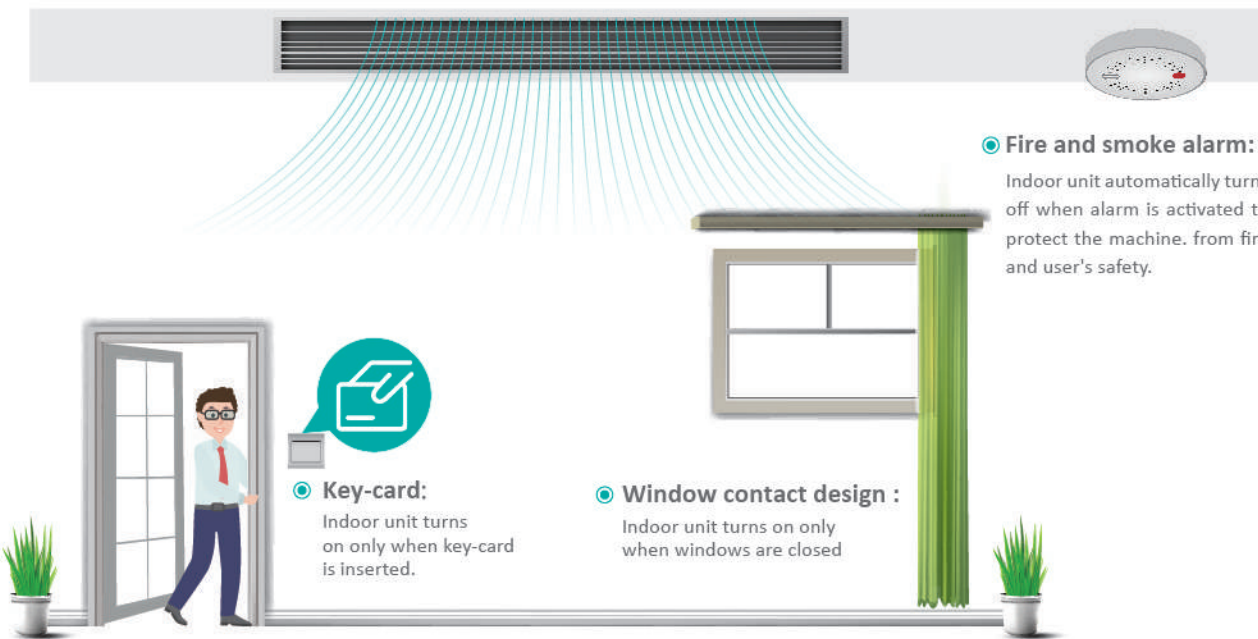

Note: this function can be achieved by the wired controller: HXXW-VA01, HXXM-VB01, HXXE-J01H

One-touch test run

Test runs are one of the essential part in testing & commissioning to make sure the HVAC system in a building works steadily and safely before hand over or soft openings. To make test run as simple as possible,

Hisense VRF systems are capable to conduct test runs with just a button away wherever installers are, despite indoors or outdoors as one-touch test run functions are applicable in both outdoor and indoor units.

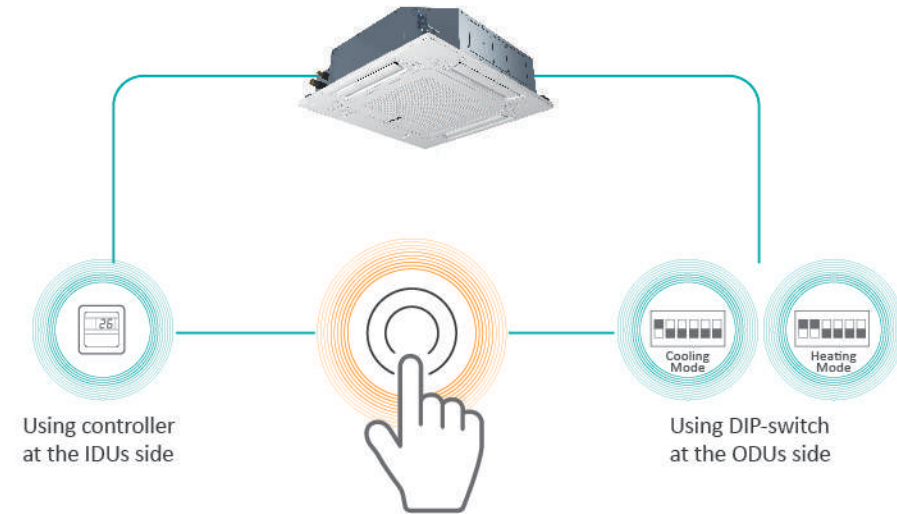

Automatic restart

Hisense VRF is capable to restart automatically whenever there is an involuntary power supply shortage. Customers are free to choose from restoring to it to the state before power failure state or restarting the

system completely. Such function comes in handy in equipment rooms whereby are constantly humanless, like server rooms.

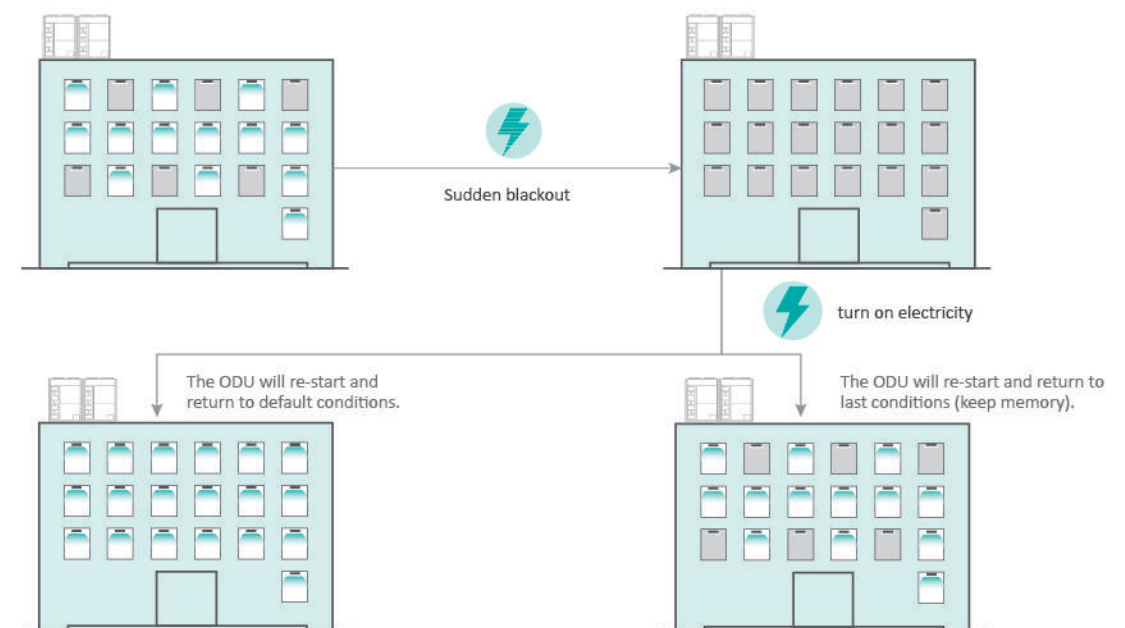

CONVENIENCE

Automatic addressing

Imagine a large system with lots of indoor units, it could be tens or even hundreds as the number of system increases. The necessity to address each units could be so troublesome hence why not letting the software to auto address each indoor units by default. Such function is very important in troubleshooting and fault diagnosis when only specific indoor units malfunctioned. It is as easy as plug and play, connect the indoor units to the outdoor units and indoor unit addresses are completely set automatically.

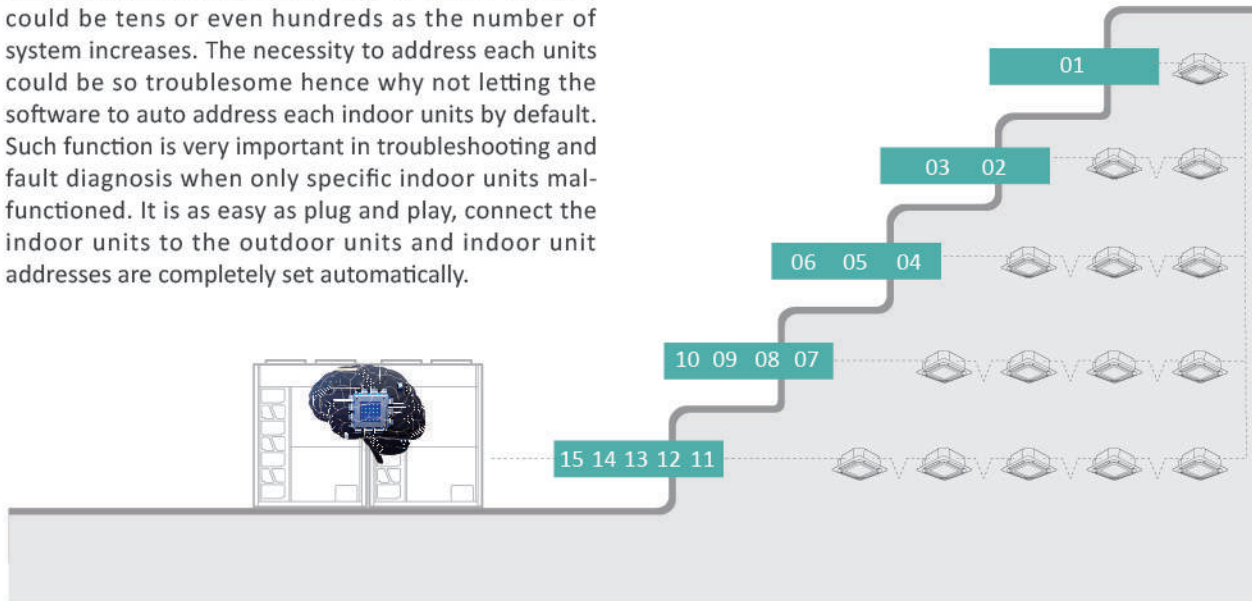

Compact and light-weight

With larger capacity per unit, Hisense VRF outdoor units are more compact in size with the largest capacity of 28HP single module, leading capacity of a single

module in the market. Compact yet reduced overall weight makes transportation much convenient and even fitting into elevators.

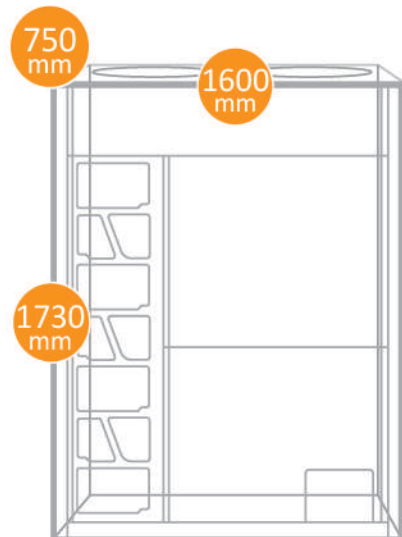

Convenient maintenance

Hi-FLEXI S Series Heat Recovery divides the electrical and mechanical compartment. Also be same with two panels. Engineers are free to take the panels apart to

check and maintain every details separately. All designs provide the convenience for installation and maintenance.

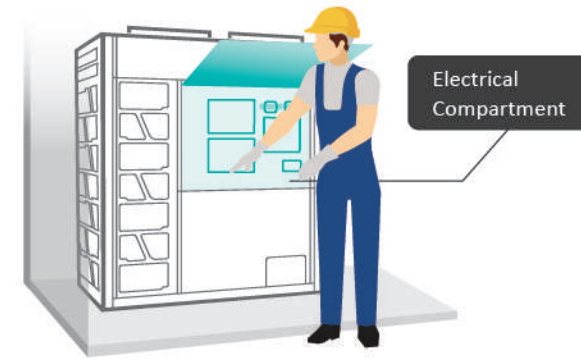

Independent maintenance

Hisense VRF is capable to isolate the malfunction unit from the others while conducting restoration and maintaining continuous operation of other units simultaneously. Especially practical for retail shops or offices

where multiple indoor units share the same system, there is a breakdown or powered cut-off during renovation of a shop does not affect shops of the same system from routine business operation.

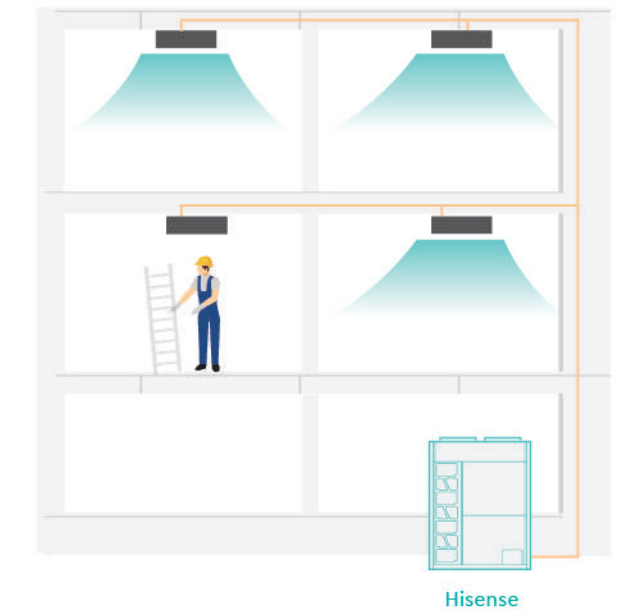
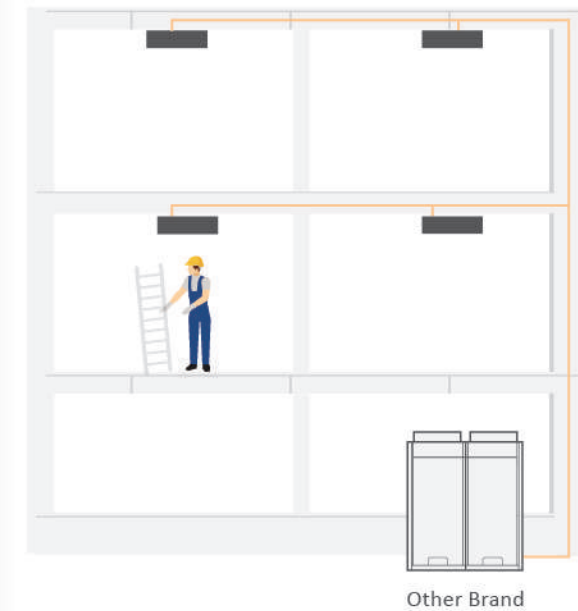

CONVENIENCE

Accurate intelligent system diagnosis

Exclusive Hisense Data Collector is another plug and play service maintenance tool for system monitoring purposes. Whereby various parameters can be monitored in real-time which made troubleshooting and prevention maintenance made so much more direct

and simple. The Data Collector has boundlessness compatibility whereby any outdoor unit or indoor unit of the system can be connected with the data collector to obtain real-time readings of the whole system.

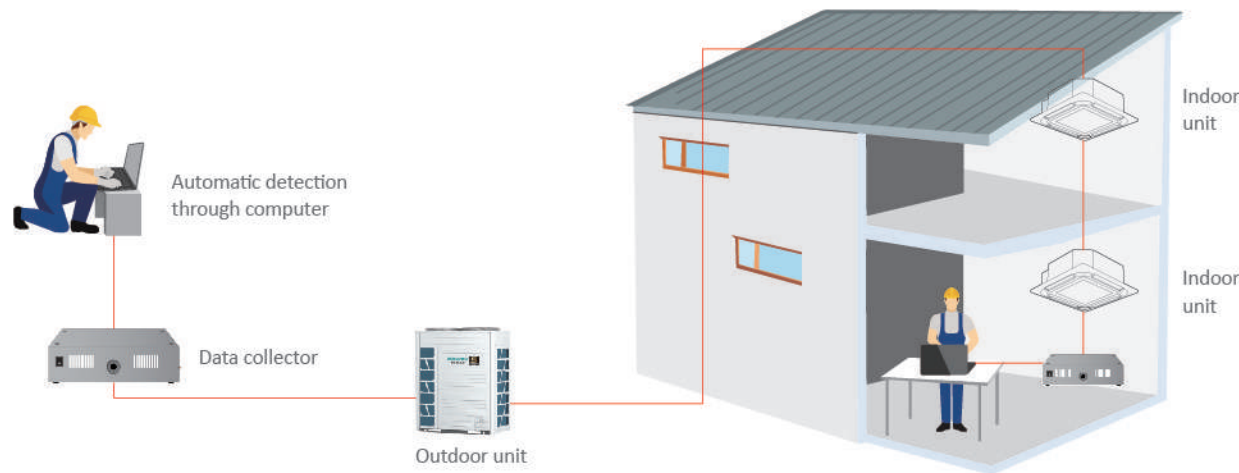

Note: The data collector is just used for maintenance.

7-segment LED on the outdoor

The 7-segment LED on the outdoor unit makes it easy to monitor and check the details about the operating status such as refrigerant temperature, pressure, com-

pressor frequency, alarm code, etc., which makes both operation management and maintenance more convenient.

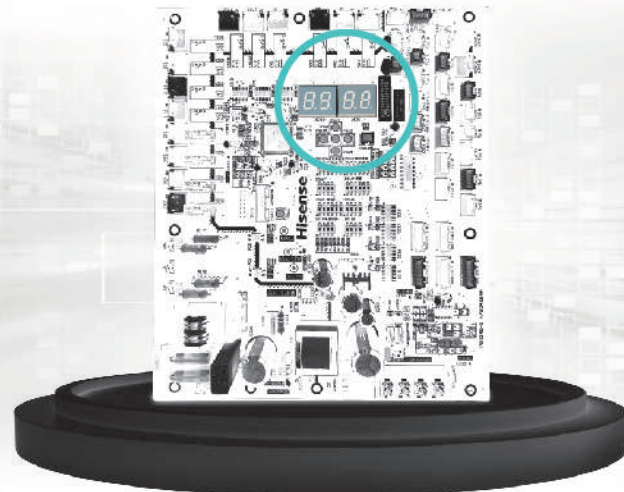

Extra long pipe design

With extra long pipe, the height difference between the indoor unit and outdoor unit is up to 90m*, which makes installation more flexible.

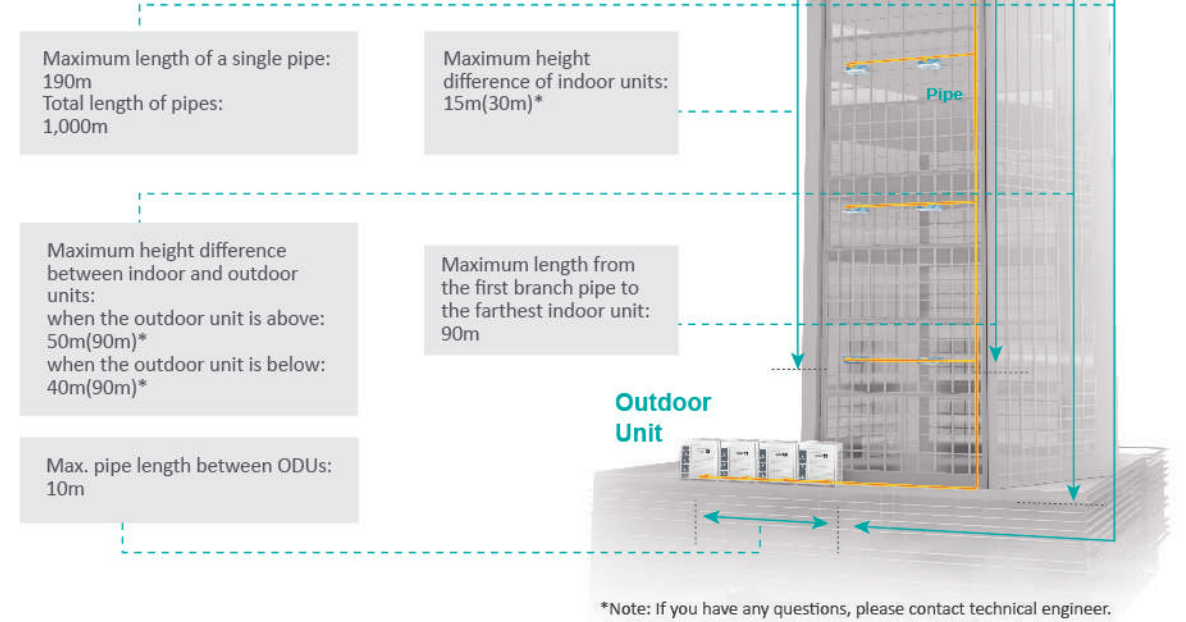

Fan static pressure adaptive technology

With static pressure adaptive technology, the fan of the outdoor unit can be adjusted in free static pressure based on system requirements to meet a variety of needs in different environments. The maximum external static pressure of the outdoor unit can be up to 110Pa*, which provides better conditions for the layered installation and centralized installation. Higher static pressure and further distance of air supply of the outdoor unit ensure the smooth flow of air and solve condensing problems of the outdoor unit effectively.

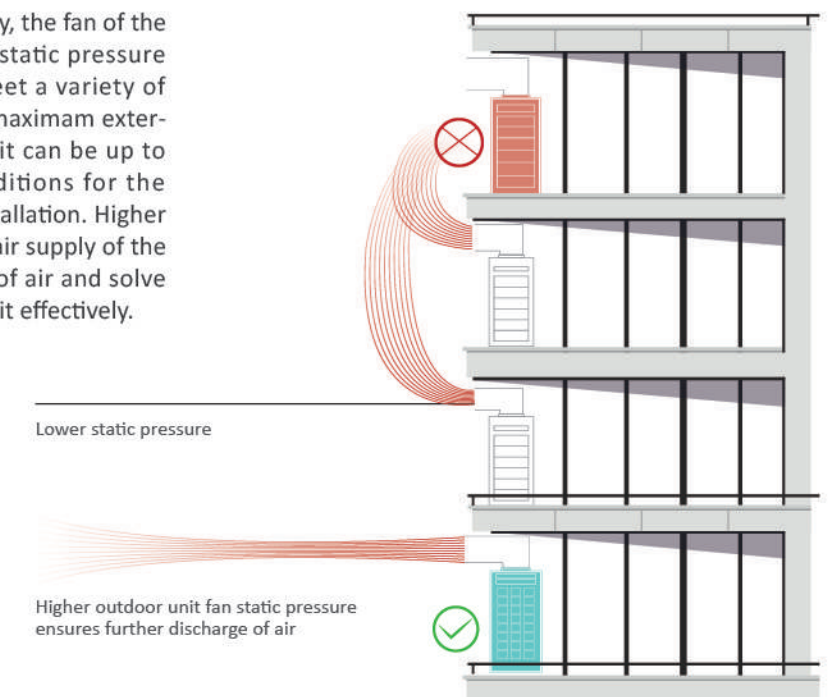

OUTDOOR UNIT

HI-FLEXI S HEAT RECOVERY



HP		8HP	10HP	12HP	14HP	16HP	18HP	
Model	Model	AVWT-76FKFSA	AVWT-96FKFSA	AVWT-114FKFSA	AVWT-136FKFSA	AVWT-154FKFSA	AVWT-170FKFSA	
	Modules	-	-	-	-	-	-	
Power Supply		AC 3Φ 380-415V/50Hz/60Hz						
Cooling	Capacity	kW	22.4	28.0	33.5	40.0	45.0	50.0
		kBtu/h	76.4	95.5	114.3	136.5	153.5	170.6
	Power Input	kW	4.87	6.75	8.09	10.26	12.16	14.04
	EER	kW/kW	4.60	4.15	4.14	3.90	3.70	3.56
Heating	Capacity	kW	25.0	31.5	37.5	45.0	50.0	56.0
		kBtu/h	85.3	107.5	128.0	153.5	170.6	191.1
	Power Input	kW	5.20	6.77	9.17	10.82	12.14	14.74
COP	kW/kW	4.81	4.65	4.09	4.16	4.12	3.80	
Ventilation	Air Flow Rate	m ³ /min	183			200		
	Fan Quantity		1			2		
Sound	Sound Pressure Level	dB(A)	59	60	62	62	62	62
Compressor	Type	-	Enhanced Vapor Injection Scroll Compressor					
	Compressor Quantity	PC	1	1	1	1	1	2
Refrigerant	Type	-	R410A					
	Pre-charged Amount	kg	5.60	5.90	6.00	8.80	8.80	9.20
Weight	Net Weight	kg	226	227	246	289	290	349
	Gross Weight	kg	246	247	266	311	312	371
Dimensions	External (H×W×D)	mm	1730×950×750			1730×1210×750		
	Packing(H×W×D)	mm	1930×1015×790			1930×1275×790		
Cabinet Color	-	Ivory White						
Heat Pump Operation System	Gas	mm	Φ19.05	Φ22.20	Φ25.40	Φ25.40	Φ28.60	Φ28.60
		in.	3/4	7/8	1	1	1-1/8	1-1/8
	Liquid	mm	Φ9.53	Φ9.53	Φ12.70	Φ12.70	Φ12.70	Φ15.88
		in.	3/8	3/8	1/2	1/2	1/2	5/8
Heat Recovery Operation System	Low Pressure Gas Line	mm	Φ19.05	Φ22.20	Φ25.40	Φ25.40	Φ28.60	Φ28.60
		in.	3/4	7/8	1	1	1-1/8	1-1/8
	High/Low Pressure Gas Line	mm	Φ15.88	Φ19.05	Φ22.2	Φ22.2	Φ22.2	Φ22.2
		in.	5/8	3/4	7/8	7/8	7/8	7/8
Liquid Line	mm	Φ9.53	Φ9.53	Φ12.70	Φ12.70	Φ12.70	Φ15.88	
	in.	3/8	3/8	1/2	1/2	1/2	5/8	
Operation Range	Cooling	°C DB	-10~52					
	Heating	°C WB	-25~16.5					

Notes:

- Rated cooling capacity and rated heating capacity are tested in the following conditions:
Cooling conditions: indoor air inlet temperature: 27°C DB 19°C WB, Outdoor air inlet temperature: 35°C DB, pipe length: 7.5m, pipe height difference: 0m
Heating conditions: indoor air inlet temperature: 20°C DB, Outdoor air inlet temperature: 7°C DB 6°C WB, pipe length: 7.5m, pipe height difference: 0m
- The above noise values are measured in the anechoic chamber without reflected echo, therefore the impact of the reflected echo must be included at the scene.
- The final appearance of outdoor units is subject to the actual products.

HI-FLEXI S HEAT RECOVERY



HP		20HP	22HP	24HP	26HP	28HP	
Model	Model	AVWT-190FKFSA	AVWT-212FKFSA	AVWT-232FKFSA	AVWT-250FKFSA	AVWT-272FKFSA	
	Modules	-	-	-	-	-	
Power Supply		AC 3Φ 380-415V/50Hz/60Hz					
Cooling	Capacity	kW	56.0	61.5	68.0	72.5	80.0
		kBtu/h	191.1	209.8	232.0	247.4	273.0
	Power Input	kW	15.60	18.04	20.61	21.90	24.24
	EER	kW/kW	3.59	3.41	3.30	3.31	3.30
Heating	Capacity	kW	63.0	69.0	75.0	80.0	90.0
		kBtu/h	215.0	235.4	255.9	273.0	307.1
	Power Input	kW	16.54	18.80	21.43	22.35	26.01
COP	kW/kW	3.81	3.67	3.50	3.58	3.46	
Ventilation	Air Flow Rate	m ³ /min	267	296	296	350	350
	Fan Quantity		2				
Sound	Sound Pressure Level	dB(A)	63	64	66	67	67
Compressor	Type	-	Enhanced Vapor Injection Scroll Compressor				
	Compressor Quantity	PC	2				
Refrigerant	Type	-	R410A				
	Pre-charged Amount	kg	9.80	10.60	10.60	11.50	11.50
Weight	Net Weight	kg	369	377	378	400	401
	Gross Weight	kg	393	401	402	426	427
Dimensions	External (H×W×D)	mm	1730×1350×750			1730×1600×750	
	Packing(H×W×D)	mm	1930×1420×790			1930×1665×790	
Cabinet Color	-	Ivory White					
Heat Pump Operation System	Gas	mm	Φ28.60	Φ28.60	Φ28.60	Φ31.75	Φ31.75
		in.	1-1/8	1-1/8	1-1/8	1-1/4	1-1/4
	Liquid	mm	Φ15.88	Φ15.88	Φ15.88	Φ19.05	Φ19.05
		in.	5/8	5/8	5/8	3/4	3/4
Heat Recovery Operation System	Low Pressure Gas Line	mm	Φ28.60	Φ28.60	Φ28.60	Φ31.75	Φ31.75
		in.	1-1/8	1-1/8	1-1/8	1-1/4	1-1/4
	High/Low Pressure Gas Line	mm	Φ22.2	Φ25.4	Φ25.4	Φ25.4	Φ28.6
		in.	7/8	1	1	1	1-1/8
Liquid Line	mm	Φ15.88	Φ15.88	Φ15.88	Φ19.05	Φ19.05	
	in.	5/8	5/8	5/8	3/4	3/4	
Operation Range	Cooling	°C DB	-10~52				
	Heating	°C WB	-25~16.5				

Notes:

- Rated cooling capacity and rated heating capacity are tested in the following conditions:
Cooling conditions: indoor air inlet temperature: 27°C DB 19°C WB, Outdoor air inlet temperature: 35°C DB, pipe length: 7.5m, pipe height difference: 0m
Heating conditions: indoor air inlet temperature: 20°C DB, Outdoor air inlet temperature: 7°C DB 6°C WB, pipe length: 7.5m, pipe height difference: 0m
- The above noise values are measured in the anechoic chamber without reflected echo, therefore the impact of the reflected echo must be included at the scene.
- The final appearance of outdoor units is subject to the actual products.

OUTDOOR UNIT

HI-FLEXI S HEAT RECOVERY



HP			30HP	32HP	34HP	36HP	38HP
Model	Model		AVWT-290FKFSA	AVWT-308FKFSA	AVWT-324FKFSA	AVWT-344FKFSA	AVWT-360FKFSA
	Modules		AVWT-136FKFSA AVWT-154FKFSA	AVWT-154FKFSA AVWT-154FKFSA	AVWT-154FKFSA AVWT-170FKFSA	AVWT-154FKFSA AVWT-190FKFSA	AVWT-170FKFSA AVWT-190FKFSA
Power Supply			AC 3Φ 380-415V/50Hz/60Hz				
Cooling	Capacity	kW	85.0	90.0	95.0	101.0	106.0
		kBtu/h	290.0	307.1	324.1	344.6	361.7
	Power Input	kW	22.41	24.32	26.20	27.75	29.64
	EER	kW/kW	3.79	3.70	3.63	3.64	3.58
Heating	Capacity	kW	95.0	100.0	106.0	113.0	119.0
		kBtu/h	324.1	341.2	361.7	385.6	406.0
	Power Input	kW	22.95	24.27	26.82	28.62	31.27
	COP	kW/kW	4.14	4.12	3.95	3.95	3.81
Ventilation	Air Flow Rate	m ³ /min	400		467		
	Fan Quantity		4				
Sound	Sound Pressure Level	dB(A)	67				
Compressor	Type	-	Enhanced Vapor Injection Scroll Compressor				
	Compressor Quantity	PC	2	2	3	3	4
Refrigerant	Type	-	R410A				
	Pre-charged Amount	kg	8.80+8.80	8.80+8.80	8.80+9.20	8.80+9.80	9.20+9.80
Weight	Net Weight	kg	289+290	290+290	290+349	290+369	349+369
	Gross Weight	kg	311+312	312+312	312+371	312+393	371+393
Dimensions	External (H×W×D)	mm	1730×(1210+1210)×750			1730×(1210+1350)×750	
	Packing(H×W×D)	mm	1930×(1275+1275)×790			1930×(1275+1420)×790	
Cabinet Color	-		Ivory White				
Heat Pump Operation System	Gas	mm	Φ31.75	Φ31.75	Φ31.75	Φ38.1	Φ38.1
		in.	1-1/4	1-1/4	1-1/4	1-1/2	1-1/2
	Liquid	mm	Φ19.05	Φ19.05	Φ19.05	Φ19.05	Φ19.05
		in.	3/4	3/4	3/4	3/4	3/4
Heat Recovery Operation System	Low Pressure Gas Line	mm	Φ31.75	Φ31.75	Φ31.75	Φ38.1	Φ38.1
		in.	1-1/4	1-1/4	1-1/4	1-1/2	1-1/2
	High/Low Pressure Gas Line	mm	Φ28.6	Φ28.6	Φ28.6	Φ28.6	Φ31.75
		in.	1-1/8	1-1/8	1-1/8	1-1/8	1-1/4
	Liquid Line	mm	Φ19.05	Φ19.05	Φ19.05	Φ19.05	Φ19.05
		in.	3/4	3/4	3/4	3/4	3/4
Operation Range	Cooling	°C DB	-10~52				
	Heating	°C WB	-25~16.5				

Notes:

- Rated cooling capacity and rated heating capacity are tested in the following conditions:
Cooling conditions: indoor air inlet temperature: 27°C DB 19°C WB, Outdoor air inlet temperature: 35°C DB, pipe length: 7.5m, pipe height difference: 0m
Heating conditions: indoor air inlet temperature: 20°C DB, Outdoor air inlet temperature: 7°C DB 6°C WB, pipe length: 7.5m, pipe height difference: 0m
- The above noise values are measured in the anechoic chamber without reflected echo, therefore the impact of the reflected echo must be included at the scene.
- The final appearance of outdoor units is subject to the actual products.

HI-FLEXI S HEAT RECOVERY



HP			40HP	42HP	44HP	46HP	48HP
Model	Model		AVWT-380FKFSA	AVWT-402FKFSA	AVWT-422FKFSA	AVWT-444FKFSA	AVWT-464FKFSA
	Modules		AVWT-190FKFSA AVWT-190FKFSA	AVWT-170FKFSA AVWT-232FKFSA	AVWT-190FKFSA AVWT-232FKFSA	AVWT-212FKFSA AVWT-232FKFSA	AVWT-232FKFSA AVWT-232FKFSA
Power Supply			AC 3Φ 380-415V/50Hz/60Hz				
Cooling	Capacity	kW	112.0	118.0	124.0	129.5	136.0
		kBtu/h	382.1	402.6	423.1	441.9	464.0
	Power Input	kW	31.20	34.60	36.15	38.63	41.21
	EER	kW/kW	3.59	3.41	3.43	3.35	3.30
Heating	Capacity	kW	126.0	131.0	138.0	144.0	150.0
		kBtu/h	429.9	447.0	470.9	491.3	511.8
	Power Input	kW	33.07	36.12	37.92	40.21	42.86
	COP	kW/kW	3.81	3.63	3.64	3.58	3.50
Ventilation	Air Flow Rate	m ³ /min	534	496	563	592	592
	Fan Quantity		4				
Sound	Sound Pressure Level	dB(A)	67	67	68	68	69
Compressor	Type	-	Enhanced Vapor Injection Scroll Compressor				
	Compressor Quantity	PC	4				
Refrigerant	Type	-	R410A				
	Pre-charged Amount	kg	9.80+9.80	9.20+10.60	9.80+10.60	10.60+10.60	10.60+10.60
Weight	Net Weight	kg	369+369	349+378	369+378	377+378	378+378
	Gross Weight	kg	393+393	371+402	393+402	401+402	402+402
Dimensions	External (H×W×D)	mm	1730×(1350+1350)×750	1730×(1210+1350)×750	1730×(1350+1350)×750		
	Packing(H×W×D)	mm	1930×(1420+1420)×790	1930×(1275+1420)×790	1930×(1420+1420)×790		
Cabinet Color	-		Ivory White				
Heat Pump Operation System	Gas	mm	Φ38.1	Φ38.1	Φ38.1	Φ38.1	Φ38.1
		in.	1-1/2	1-1/2	1-1/2	1-1/2	1-1/2
	Liquid	mm	Φ19.05	Φ19.05	Φ19.05	Φ19.05	Φ19.05
		in.	3/4	3/4	3/4	3/4	3/4
Heat Recovery Operation System	Low Pressure Gas Line	mm	Φ38.1	Φ38.1	Φ38.1	Φ38.1	Φ38.1
		in.	1-1/2	1-1/2	1-1/2	1-1/2	1-1/2
	High/Low Pressure Gas Line	mm	Φ31.75	Φ31.75	Φ31.75	Φ31.75	Φ31.75
		in.	1-1/4	1-1/4	1-1/4	1-1/4	1-1/4
	Liquid Line	mm	Φ19.05	Φ19.05	Φ19.05	Φ19.05	Φ19.05
		in.	3/4	3/4	3/4	3/4	3/4
Operation Range	Cooling	°C DB	-10~52				
	Heating	°C WB	-25~16.5				

Notes:

- Rated cooling capacity and rated heating capacity are tested in the following conditions:
Cooling conditions: indoor air inlet temperature: 27°C DB 19°C WB, Outdoor air inlet temperature: 35°C DB, pipe length: 7.5m, pipe height difference: 0m
Heating conditions: indoor air inlet temperature: 20°C DB, Outdoor air inlet temperature: 7°C DB 6°C WB, pipe length: 7.5m, pipe height difference: 0m
- The above noise values are measured in the anechoic chamber without reflected echo, therefore the impact of the reflected echo must be included at the scene.
- The final appearance of outdoor units is subject to the actual products.

OUTDOOR UNIT

HI-FLEXI S HEAT RECOVERY



HP			50HP	52HP	54HP	56HP
Model	Model		AVWT-482FKFSA	AVWT-504FKFSA	AVWT-522FKFSA	AVWT-544FKFSA
	Modules		AVWT-232FKFSA AVWT-250FKFSA	AVWT-232FKFSA AVWT-272FKFSA	AVWT-250FKFSA AVWT-272FKFSA	AVWT-272FKFSA AVWT-272FKFSA
Power Supply			AC 3Φ 380-415V/50Hz/60Hz			
Cooling	Capacity	kW	140.5	148.0	152.5	160.0
		kBtu/h	479.4	505.0	520.3	545.9
	Power Input	kW	42.51	44.85	46.15	48.48
	EER	kW/kW	3.31	3.30	3.30	3.30
Heating	Capacity	kW	155.0	165.0	170.0	180.0
		kBtu/h	528.9	563.0	580.0	614.2
	Power Input	kW	43.77	47.44	48.33	52.02
	COP	kW/kW	3.54	3.48	3.52	3.46
Ventilation	Air Flow Rate	m ³ /min	646		700	
	Fan Quantity		4			
Sound	Sound Pressure Level	dB(A)	70			
Compressor	Type	-	Enhanced Vapor Injection Scroll Compressor			
	Compressor Quantity	PC	4			
Refrigerant	Type	-	R410A			
	Pre-charged Amount	kg	10.60+11.50	10.60+11.50	11.50+11.50	11.50+11.50
Weight	Net Weight	kg	378+400	378+401	400+401	401+401
	Gross Weight	kg	402+426	402+427	426+427	427+427
Dimensions	External (H×W×D)	mm	1730×(1350+1600)×750		1730×(1600+1600)×750	
	Packing(H×W×D)	mm	1930×(1420+1665)×790		1930×(1665+1665)×790	
Cabinet Color	-		Ivory White			
Heat Pump Operation System	Gas	mm	Φ38.1	Φ38.1	Φ38.1	Φ41.3
		in.	1-1/2	1-1/2	1-1/2	1-5/8
	Liquid	mm	Φ19.05	Φ19.05	Φ19.05	Φ22.2
		in.	3/4	3/4	3/4	7/8
Heat Recovery Operation System	Low Pressure Gas Line	mm	Φ38.1	Φ38.1	Φ38.1	Φ41.3
		in.	1-1/2	1-1/2	1-1/2	1-5/8
	High/Low Pressure Gas Line	mm	Φ31.75	Φ31.75	Φ31.75	Φ38.1
		in.	1-1/4	1-1/4	1-1/4	1-1/2
	Liquid Line	mm	Φ19.05	Φ19.05	Φ19.05	Φ22.2
		in.	3/4	3/4	3/4	7/8
Operation Range	Cooling	°C DB	-10~52			
	Heating	°C WB	-25~16.5			

Notes:

- Rated cooling capacity and rated heating capacity are tested in the following conditions:
Cooling conditions: indoor air inlet temperature: 27°C DB 19°C WB, Outdoor air inlet temperature: 35°C DB, pipe length: 7.5m, pipe height difference: 0m
Heating conditions: indoor air inlet temperature: 20°C DB, Outdoor air inlet temperature: 7°C DB 6°C WB, pipe length: 7.5m, pipe height difference: 0m
- The above noise values are measured in the anechoic chamber without reflected echo, therefore the impact of the reflected echo must be included at the scene.
- The final appearance of outdoor units is subject to the actual products.

HI-FLEXI S HEAT RECOVERY



HP			58HP	60HP	62HP	64HP
Model	Model		AVWT-552FKFSA	AVWT-570FKFSA	AVWT-592FKFSA	AVWT-612FKFSA
	Modules		AVWT-170FKFSA AVWT-170FKFSA AVWT-212FKFSA	AVWT-190FKFSA AVWT-190FKFSA AVWT-190FKFSA	AVWT-170FKFSA AVWT-190FKFSA AVWT-232FKFSA	AVWT-190FKFSA AVWT-190FKFSA AVWT-232FKFSA
Power Supply			AC 3Φ 380-415V/50Hz/60Hz			
Cooling	Capacity	kW	161.5	168.0	174.0	180.0
		kBtu/h	551.0	573.2	593.7	614.2
	Power Input	kW	46.11	46.80	50.18	51.72
	EER	kW/kW	3.50	3.59	3.47	3.48
Heating	Capacity	kW	181.0	189.0	194.0	201.0
		kBtu/h	617.6	644.9	661.9	685.8
	Power Input	kW	48.27	49.61	52.64	54.43
	COP	kW/kW	3.75	3.81	3.69	3.69
Ventilation	Air Flow Rate	m ³ /min	696	801	763	830
	Fan Quantity		6			
Sound	Sound Pressure Level	dB(A)	70			
Compressor	Type	-	Enhanced Vapor Injection Scroll Compressor			
	Compressor Quantity	PC	6			
Refrigerant	Type	-	R410A			
	Pre-charged Amount	kg	9.20+9.20+10.60	9.80+9.80+9.80	9.20+9.80+10.60	9.80+9.80+10.60
Weight	Net Weight	kg	349+349+377	369+369+369	349+369+378	369+369+378
	Gross Weight	kg	371+371+401	393+393+393	371+393+402	393+393+402
Dimensions	External (H×W×D)	mm	1730×(1210+1210+1350)×750	1730×(1350+1350+1350)×750	1730×(1210+1350+1350)×750	1730×(1350+1350+1350)×750
	Packing(H×W×D)	mm	1930×(1275+1275+1420)×790	1930×(1420+1420+1420)×790	1930×(1275+1420+1420)×790	1930×(1420+1420+1420)×790
Cabinet Color	-		Ivory White			
Heat Pump Operation System	Gas	mm	Φ44.5			
		in.	1-3/4			
	Liquid	mm	Φ22.2			
		in.	7/8			
Heat Recovery Operation System	Low Pressure Gas Line	mm	Φ44.5			
		in.	1-3/4			
	High/Low Pressure Gas Line	mm	Φ41.3			
		in.	1-5/8			
	Liquid Line	mm	Φ22.2			
		in.	7/8			
Operation Range	Cooling	°C DB	-10~52			
	Heating	°C WB	-25~16.5			

Notes:

- Rated cooling capacity and rated heating capacity are tested in the following conditions:
Cooling conditions: indoor air inlet temperature: 27°C DB 19°C WB, Outdoor air inlet temperature: 35°C DB, pipe length: 7.5m, pipe height difference: 0m
Heating conditions: indoor air inlet temperature: 20°C DB, Outdoor air inlet temperature: 7°C DB 6°C WB, pipe length: 7.5m, pipe height difference: 0m
- The above noise values are measured in the anechoic chamber without reflected echo, therefore the impact of the reflected echo must be included at the scene.
- The final appearance of outdoor units is subject to the actual products.

OUTDOOR UNIT

HI-FLEXI S HEAT RECOVERY



HP			66HP	68HP	70HP	72HP
Model	Model		AVWT-634FKFSA	AVWT-654FKFSA	AVWT-676FKFSA	AVWT-696FKFSA
	Modules		AVWT-190FKFSA AVWT-212FKFSA AVWT-232FKFSA	AVWT-190FKFSA AVWT-232FKFSA AVWT-232FKFSA	AVWT-212FKFSA AVWT-232FKFSA AVWT-232FKFSA	AVWT-232FKFSA AVWT-232FKFSA AVWT-232FKFSA
Power Supply			AC 3Φ 380-415V/50Hz/60Hz			
Cooling	Capacity	kW	185.5	192.0	197.5	204.0
		kBtu/h	632.9	655.1	673.9	696.0
	Power Input	kW	54.18	56.73	59.23	61.82
	EER	kW/kW	3.42	3.38	3.33	3.30
Heating	Capacity	kW	207.0	213.0	219.0	225.0
		kBtu/h	706.3	726.8	747.2	767.7
	Power Input	kW	56.72	59.33	61.63	64.29
	COP	kW/kW	3.65	3.59	3.55	3.50
Ventilation	Air Flow Rate	m ³ /min	859		888	
	Fan Quantity		6			
Sound	Sound Pressure Level	dB(A)	70	70	70	71
Compressor	Type	-	Enhanced Vapor Injection Scroll Compressor			
	Compressor Quantity	PC	6			
Refrigerant	Type	-	R410A			
	Pre-charged Amount	kg	9.80+10.60+10.60	9.80+10.60+10.60	10.60+10.60+10.60	10.60+10.60+10.60
Weight	Net Weight	kg	369+377+378	369+378+378	377+378+378	378+378+378
	Gross Weight	kg	393+401+402	393+402+402	401+402+402	402+402+402
Dimensions	External (HxWxD)	mm	1730x(1350+1350+1350)x750			
	Packing(HxWxD)	mm	1930x(1420+1420+1420)x790			
Cabinet Color	-		Ivory White			
Heat Pump Operation System	Gas	mm	Φ44.5	Φ50.8	Φ50.8	Φ50.8
		in.	1-3/4	2	2	2
	Liquid	mm	Φ22.2	Φ25.4	Φ25.4	Φ25.4
		in.	7/8	1	1	1
Heat Recovery Operation System	Low Pressure Gas Line	mm	Φ44.5	Φ50.8	Φ50.8	Φ50.8
		in.	1-3/4	2	2	2
	High/Low Pressure Gas Line	mm	Φ41.3	Φ44.5	Φ44.5	Φ44.5
		in.	1-5/8	1-3/4	1-3/4	1-3/4
	Liquid Line	mm	Φ22.2	Φ25.4	Φ25.4	Φ25.4
		in.	7/8	1	1	1
Operation Range	Cooling	°C DB	-10~52			
	Heating	°C WB	-25~16.5			

Notes:

- Rated cooling capacity and rated heating capacity are tested in the following conditions:
Cooling conditions: indoor air inlet temperature: 27°C DB 19°C WB, Outdoor air inlet temperature: 35°C DB, pipe length: 7.5m, pipe height difference: 0m
Heating conditions: indoor air inlet temperature: 20°C DB, Outdoor air inlet temperature: 7°C DB 6°C WB, pipe length: 7.5m, pipe height difference: 0m
- The above noise values are measured in the anechoic chamber without reflected echo, therefore the impact of the reflected echo must be included at the scene.
- The final appearance of outdoor units is subject to the actual products.

HI-FLEXI S HEAT RECOVERY



HP			74HP	76HP	78HP	80HP
Model	Model		AVWT-714FKFSA	AVWT-732FKFSA	AVWT-754FKFSA	AVWT-776FKFSA
	Modules		AVWT-232FKFSA AVWT-232FKFSA AVWT-250FKFSA	AVWT-232FKFSA AVWT-250FKFSA AVWT-250FKFSA	AVWT-232FKFSA AVWT-250FKFSA AVWT-272FKFSA	AVWT-232FKFSA AVWT-272FKFSA AVWT-272FKFSA
Power Supply			AC 3Φ 380-415V/50Hz/60Hz			
Cooling	Capacity	kW	208.5	213.0	220.5	228.0
		kBtu/h	711.4	726.8	752.3	777.9
	Power Input	kW	63.11	64.41	66.75	69.09
	EER	kW/kW	3.30	3.31	3.30	3.30
Heating	Capacity	kW	230.0	235.0	245.0	255.0
		kBtu/h	784.8	801.8	835.9	870.1
	Power Input	kW	65.19	66.11	69.76	73.45
	COP	kW/kW	3.53	3.55	3.51	3.47
Ventilation	Air Flow Rate	m ³ /min	942	996	996	996
	Fan Quantity		6			
Sound	Sound Pressure Level	dB(A)	71			
Compressor	Type	-	Enhanced Vapor Injection Scroll Compressor			
	Compressor Quantity	PC	6			
Refrigerant	Type	-	R410A			
	Pre-charged Amount	kg	10.60+10.60+11.50	10.60+11.50+11.50	10.60+11.50+11.50	10.60+11.50+11.50
Weight	Net Weight	kg	378+378+400	378+400+400	378+400+401	378+401+401
	Gross Weight	kg	402+402+426	402+426+426	402+426+427	402+427+427
Dimensions	External (HxWxD)	mm	1730x(1350+1350+1600)x750	1730x(1350+1600+1600)x750	1730x(1350+1600+1600)x750	1730x(1350+1600+1600)x750
	Packing(HxWxD)	mm	1930x(1420+1420+1665)x790	1930x(1420+1665+1665)x790	1930x(1420+1665+1665)x790	1930x(1420+1665+1665)x790
Cabinet Color	-		Ivory White			
Heat Pump Operation System	Gas	mm	Φ50.8			
		in.	2			
	Liquid	mm	Φ25.4			
		in.	1			
Heat Recovery Operation System	Low Pressure Gas Line	mm	Φ50.8			
		in.	2			
	High/Low Pressure Gas Line	mm	Φ44.5			
		in.	1-3/4			
	Liquid Line	mm	Φ25.4			
		in.	1			
Operation Range	Cooling	°C DB	-10~52			
	Heating	°C WB	-25~16.5			

Notes:

- Rated cooling capacity and rated heating capacity are tested in the following conditions:
Cooling conditions: indoor air inlet temperature: 27°C DB 19°C WB, Outdoor air inlet temperature: 35°C DB, pipe length: 7.5m, pipe height difference: 0m
Heating conditions: indoor air inlet temperature: 20°C DB, Outdoor air inlet temperature: 7°C DB 6°C WB, pipe length: 7.5m, pipe height difference: 0m
- The above noise values are measured in the anechoic chamber without reflected echo, therefore the impact of the reflected echo must be included at the scene.
- The final appearance of outdoor units is subject to the actual products.

OUTDOOR UNIT

HI-FLEXI S HEAT RECOVERY



HP		82HP	84HP	86HP	88HP	
Model	Model	AVWT-794FKFSA	AVWT-816FKFSA	AVWT-824FKFSA	AVWT-844FKFSA	
	Modules	AVWT-250FKFSA AVWT-272FKFSA AVWT-272FKFSA	AVWT-272FKFSA AVWT-272FKFSA AVWT-272FKFSA	AVWT-190FKFSA AVWT-190FKFSA AVWT-212FKFSA AVWT-232FKFSA	AVWT-190FKFSA AVWT-190FKFSA AVWT-232FKFSA AVWT-232FKFSA	
Power Supply		AC 3Φ 380-415V/50Hz/60Hz				
Cooling	Capacity	kW	232.5	240.0	241.5	248.0
		kBtu/h	793.3	818.9	824.0	846.2
	Power Input	kW	70.39	72.73	69.76	72.29
	EER	kW/kW	3.30	3.30	3.46	3.43
Heating	Capacity	kW	260.0	270.0	270.0	276.0
		kBtu/h	887.1	921.2	921.2	941.7
	Power Input	kW	74.33	78.03	73.24	75.83
	COP	kW/kW	3.50	3.46	3.69	3.64
Ventilation	Air Flow Rate	m ³ /min		1050	1126	
	Fan Quantity			6	8	
Sound	Sound Pressure Level	dB(A)		72		
Compressor	Type	Enhanced Vapor Injection Scroll Compressor				
	Compressor Quantity	PC		6	8	
Refrigerant	Type	R410A				
	Pre-charged Amount	kg	11.50+11.50+11.50	11.50+11.50+11.50	9.80+9.80+10.60+10.60	9.80+9.80+10.60+10.60
Weight	Net Weight	kg	400+401+401	401+401+401	369+369+377+378	369+369+378+378
	Gross Weight	kg	426+427+427	427+427+427	393+393+401+402	393+393+402+402
Dimensions	External (HxWxD)	mm	1730x(1600+1600+1600)x750		1730x(1350+1350+1350+1350)x750	
	Packing(HxWxD)	mm	1930x(1665+1665+1665)x790		1930x(1420+1420+1420+1420)x790	
Cabinet Color	Ivory White					
Heat Pump Operation System	Gas	mm	Φ50.8			
		in.	2			
	Liquid	mm	Φ25.4			
		in.	1			
Heat Recovery Operation System	Low Pressure Gas Line	mm	Φ50.8			
		in.	2			
	High/Low Pressure Gas Line	mm	Φ44.5			
		in.	1-3/4			
	Liquid Line	mm	Φ25.4			
		in.	1			
Operation Range	Cooling	°C DB	-10~52			
	Heating	°C WB	-25~16.5			

Notes:

- Rated cooling capacity and rated heating capacity are tested in the following conditions:
Cooling conditions: indoor air inlet temperature: 27°C DB 19°C WB, Outdoor air inlet temperature: 35°C DB, pipe length: 7.5m, pipe height difference: 0m
Heating conditions: indoor air inlet temperature: 20°C DB, Outdoor air inlet temperature: 7°C DB 6°C WB, pipe length: 7.5m, pipe height difference: 0m
- The above noise values are measured in the anechoic chamber without reflected echo, therefore the impact of the reflected echo must be included at the scene.
- The final appearance of outdoor units is subject to the actual products.

HI-FLEXI S HEAT RECOVERY



HP		90HP	92HP	94HP	96HP	
Model	Model	AVWT-866FKFSA	AVWT-886FKFSA	AVWT-908FKFSA	AVWT-928FKFSA	
	Modules	AVWT-190FKFSA AVWT-212FKFSA AVWT-232FKFSA AVWT-232FKFSA	AVWT-190FKFSA AVWT-232FKFSA AVWT-232FKFSA AVWT-232FKFSA	AVWT-212FKFSA AVWT-232FKFSA AVWT-232FKFSA AVWT-232FKFSA	AVWT-232FKFSA AVWT-232FKFSA AVWT-232FKFSA AVWT-232FKFSA	
Power Supply		AC 3Φ 380-415V/50Hz/60Hz				
Cooling	Capacity	kW	253.5	260.0	265.5	272.0
		kBtu/h	864.9	887.1	905.9	928.1
	Power Input	kW	74.77	77.33	79.83	82.42
	EER	kW/kW	3.39	3.36	3.33	3.30
Heating	Capacity	kW	282.0	288.0	294.0	300.0
		kBtu/h	962.2	982.7	1003.1	1023.6
	Power Input	kW	78.12	80.75	83.06	85.71
	COP	kW/kW	3.61	3.57	3.54	3.50
Ventilation	Air Flow Rate	m ³ /min		1155	1184	
	Fan Quantity			8	8	
Sound	Sound Pressure Level	dB(A)		72		
Compressor	Type	Enhanced Vapor Injection Scroll Compressor				
	Compressor Quantity	PC		8	8	
Refrigerant	Type	R410A				
	Pre-charged Amount	kg	9.80+10.60+10.60+10.60	9.80+10.60+10.60+10.60	10.60+10.60+10.60+10.60	10.60+10.60+10.60+10.60
Weight	Net Weight	kg	369+377+378+378	369+378+378+378	377+378+378+378	378+378+378+378
	Gross Weight	kg	393+401+402+402	393+402+402+402	401+402+402+402	402+402+402+402
Dimensions	External (HxWxD)	mm	1730x(1350+1350+1350+1350)x750			
	Packing(HxWxD)	mm	1930x(1420+1420+1420+1420)x790			
Cabinet Color	Ivory White					
Heat Pump Operation System	Gas	mm	Φ50.8			
		in.	2			
	Liquid	mm	Φ25.4			
		in.	1			
Heat Recovery Operation System	Low Pressure Gas Line	mm	Φ50.8			
		in.	2			
	High/Low Pressure Gas Line	mm	Φ44.5			
		in.	1-3/4			
	Liquid Line	mm	Φ25.4			
		in.	1			
Operation Range	Cooling	°C DB	-10~52			
	Heating	°C WB	-25~16.5			

Notes:

- Rated cooling capacity and rated heating capacity are tested in the following conditions:
Cooling conditions: indoor air inlet temperature: 27°C DB 19°C WB, Outdoor air inlet temperature: 35°C DB, pipe length: 7.5m, pipe height difference: 0m
Heating conditions: indoor air inlet temperature: 20°C DB, Outdoor air inlet temperature: 7°C DB 6°C WB, pipe length: 7.5m, pipe height difference: 0m
- The above noise values are measured in the anechoic chamber without reflected echo, therefore the impact of the reflected echo must be included at the scene.
- The final appearance of outdoor units is subject to the actual products.

OUTDOOR UNIT

HI-FLEXI S HEAT RECOVERY



HP		98HP	100HP	102HP	104HP	
Model	Model	AVWT-946FKFSA	AVWT-968FKFSA	AVWT-988FKFSA	AVWT-1008FKFSA	
	Modules	AVWT-232FKFSA AVWT-232FKFSA AVWT-232FKFSA AVWT-250FKFSA	AVWT-232FKFSA AVWT-232FKFSA AVWT-272FKFSA AVWT-272FKFSA	AVWT-212FKFSA AVWT-232FKFSA AVWT-272FKFSA AVWT-272FKFSA	AVWT-232FKFSA AVWT-232FKFSA AVWT-272FKFSA AVWT-272FKFSA	
Power Supply		AC 3Φ 380-415V/50Hz/60Hz				
Cooling	Capacity	kW	276.5	284.0	289.5	296.0
		kBtu/h	943.4	969.0	987.8	1010.0
	Power Input	kW	83.72	86.06	87.10	89.70
	EER	kW/kW	3.30	3.30	3.32	3.30
Heating	Capacity	kW	305.0	315.0	324.0	330.0
		kBtu/h	1040.7	1074.8	1105.5	1126.0
	Power Input	kW	86.62	90.29	92.19	94.87
	COP	kW/kW	3.52	3.49	3.51	3.48
Ventilation	Air Flow Rate	m ³ /min	1238		1292	
	Fan Quantity		8			
Sound	Sound Pressure Level	dB(A)	72	72	72	73
Compressor	Type	-	Enhanced Vapor Injection Scroll Compressor			
	Compressor Quantity	PC	8			
Refrigerant	Type	-	R410A			
	Pre-charged Amount	kg	10.60+10.60+10.60+11.50	10.60+10.60+10.60+11.50	10.60+10.60+11.50+11.50	10.60+10.60+11.50+11.50
Weight	Net Weight	kg	378+378+378+400	378+378+378+401	377+378+401+401	378+378+401+401
	Gross Weight	kg	402+402+402+426	402+402+402+427	401+402+427+427	402+402+427+427
Dimensions	External (HxWxD)	mm	1730x(1350+1350+1350+1600)x750		1730x(1350+1350+1600+1600)x750	
	Packing(HxWxD)	mm	1930x(1420+1420+1420+1665)x790		1930x(1420+1420+1665+1665)x790	
Cabinet Color	-		Ivory White			
Heat Pump Operation System	Gas	mm	Φ50.8			
		in.	2			
	Liquid	mm	Φ25.4			
		in.	1			
Heat Recovery Operation System	Low Pressure Gas Line	mm	Φ50.8			
		in.	2			
	High/Low Pressure Gas Line	mm	Φ44.5			
		in.	1-3/4			
	Liquid Line	mm	Φ25.4			
		in.	1			
Operation Range	Cooling	°C DB	-10~52			
	Heating	°C WB	-25~16.5			

Notes:

- Rated cooling capacity and rated heating capacity are tested in the following conditions:
Cooling conditions: indoor air inlet temperature: 27°C DB 19°C WB, Outdoor air inlet temperature: 35°C DB, pipe length: 7.5m, pipe height difference: 0m
Heating conditions: indoor air inlet temperature: 20°C DB, Outdoor air inlet temperature: 7°C DB 6°C WB, pipe length: 7.5m, pipe height difference: 0m
- The above noise values are measured in the anechoic chamber without reflected echo, therefore the impact of the reflected echo must be included at the scene.
- The final appearance of outdoor units is subject to the actual products.

HI-FLEXI S HEAT RECOVERY



HP		106HP	108HP	110HP	112HP	
Model	Model	AVWT-1026FKFSA	AVWT-1048FKFSA	AVWT-1066FKFSA	AVWT-1088FKFSA	
	Modules	AVWT-232FKFSA AVWT-250FKFSA AVWT-272FKFSA AVWT-272FKFSA	AVWT-232FKFSA AVWT-272FKFSA AVWT-272FKFSA AVWT-272FKFSA	AVWT-250FKFSA AVWT-272FKFSA AVWT-272FKFSA AVWT-272FKFSA	AVWT-272FKFSA AVWT-272FKFSA AVWT-272FKFSA AVWT-272FKFSA	
Power Supply		AC 3Φ 380-415V/50Hz/60Hz				
Cooling	Capacity	kW	300.5	308.0	312.5	320.0
		kBtu/h	1025.3	1050.9	1066.3	1091.8
	Power Input	kW	90.99	93.33	94.63	96.97
	EER	kW/kW	3.30	3.30	3.30	3.30
Heating	Capacity	kW	335.0	345.0	350.0	360.0
		kBtu/h	1143.0	1177.1	1194.2	1228.3
	Power Input	kW	95.76	99.46	100.34	104.05
	COP	kW/kW	3.50	3.47	3.49	3.46
Ventilation	Air Flow Rate	m ³ /min	1346		1400	
	Fan Quantity		8			
Sound	Sound Pressure Level	dB(A)	73			
Compressor	Type	-	Enhanced Vapor Injection Scroll Compressor			
	Compressor Quantity	PC	8			
Refrigerant	Type	-	R410A			
	Pre-charged Amount	kg	10.60+11.50+11.50+11.50	10.60+11.50+11.50+11.50	11.50+11.50+11.50+11.50	11.50+11.50+11.50+11.50
Weight	Net Weight	kg	378+400+401+401	378+401+401+401	400+401+401+401	401+401+401+401
	Gross Weight	kg	402+426+427+427	402+427+427+427	426+427+427+427	427+427+427+427
Dimensions	External (HxWxD)	mm	1730x(1350+1600+1600+1600)x750		1730x(1600+1600+1600+1600)x750	
	Packing(HxWxD)	mm	1930x(1420+1665+1665+1665)x790		1930x(1665+1665+1665+1665)x790	
Cabinet Color	-		Ivory White			
Heat Pump Operation System	Gas	mm	Φ50.8			
		in.	2			
	Liquid	mm	Φ25.4			
		in.	1			
Heat Recovery Operation System	Low Pressure Gas Line	mm	Φ50.8			
		in.	2			
	High/Low Pressure Gas Line	mm	Φ44.5			
		in.	1-3/4			
	Liquid Line	mm	Φ25.4			
		in.	1			
Operation Range	Cooling	°C DB	-10~52			
	Heating	°C WB	-25~16.5			

Notes:

- Rated cooling capacity and rated heating capacity are tested in the following conditions:
Cooling conditions: indoor air inlet temperature: 27°C DB 19°C WB, Outdoor air inlet temperature: 35°C DB, pipe length: 7.5m, pipe height difference: 0m
Heating conditions: indoor air inlet temperature: 20°C DB, Outdoor air inlet temperature: 7°C DB 6°C WB, pipe length: 7.5m, pipe height difference: 0m
- The above noise values are measured in the anechoic chamber without reflected echo, therefore the impact of the reflected echo must be included at the scene.
- The final appearance of outdoor units is subject to the actual products.

NEW SWITCH BOX

Introduction

Used for heat recovery systems to achieve simultaneous cooling and heating in a system, it is very important to realize installation flexibility and reduce costs.

Advantage

- Enrich the products (1,4,8,12,16) .
- Maximize capacity to 16kW or more.
- Require no drain pipes or drainage connections.
- Provide compact and lightweight design.
- Combine between single branch and multi-branch flexibility.
- Enable fewer connections, hooks and service parts for easy installation.

Original Products

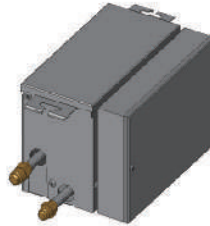

New Switch Box



Model	Single Branch		Multiple Branch					
	HCHS-N06XA	HCHS-N10XA	HCHM-N04XA	HCHM-N08XA	HCHM-N12XA	HCHM-N16XA		
Power Supply	220-240V/50Hz							
Number of Ports (for Indoor Unit)	1	1	4	8	12	16		
Outer Dimensions (H*W*D)	mm	301x191x214	301x191x214	303x352x260	543x352x260	783x352x260	1023x352x260	
Net Weight	kg	6.3	6.4	14.1	25.2	35.5	46.7	
Max. Number of Connected IDUs Per Port		8	8	8	8	6	6	
Max. Total Capacity of Connected IDUs Per Port	kW	16	28	16	16	16	16	
Maximum Total Capacity of All Connected IDUs	kW	16	28	44.8	85	85	85	
Operation Sound	dB(A)	33	33	31	31	34	34	
Refrigerant Piping	Gas Line (High/Low Pressure)	mm	15.88	15.88	22.2	22.2	25.4	28.6
	Gas Line (Low Pressure)	mm	19.05	19.05	25.4	28.6	28.6	31.75
	Liquid Line	mm	—	—	12.7	12.7	15.88	19.05
Refrigerant Piping (from IDUs)	Gas Line	mm	15.88	19.05	15.88	15.88	15.88	15.88
	Liquid Line	mm	—	—	9.53	9.53	9.53	9.53

HYDRO BOX

Specification for Hydro Box

Hydro Box Model	AHM-080FJFAA	AHM-160FJFAA		
Power Supply	AC 1Φ 220-240V/50Hz/60Hz			
Cooling Capacity (A 35/24°C /W 12-7°C)	7.5	12.5		
Heating Capacity (A 7/6°C /W 30-35°C)	8	16		
Nominal Power Input	0.08(3.08)	0.14(3.14)		
Dimensions	H×W×D	mm	890×520×320	890×520×320
Packing Dimensions	H×W×D	mm	1120×595×462	1120×595×462
Weight	Net	kg	55	58
	Gross	kg	72	75
Heat Exchanger	Plate Heat Exchanger			
Heat Exchanger Insulation Material	Elastomeric Foam			
Water Production	Heating	°C	20 to 55	
	DHW(with electric heater)	°C	35 to 75	
	Cooling	°C	5 to 20	
Sound Pressure		dB(A)	33	
Sound Power		dB(A)	46	
Piping Connections	Gas	mm	Φ9.53	
	Liquid	mm	Φ15.88	
Water Pump	Type		DC Motor	
	Speed		Inverter Control	
	Pumping Head	m	12.5	12.5
Pumping Head for Water Circuit			5	5
Power Input	w	100	160	
Booster Heating		kW	3	3
Water Filter	Diameter Perforations	mm	0.85	0.85
	Material		Hpb59-1	Hpb59-1
Water Circuit	Piping Connections Diameter	mm	G1-1/4"	G1-1/4"
	Shut off Valve		Yes	Yes
	Drain Valve		Yes	Yes
	Safety Valve	Bar	3	3
	Air Purge Valve		Yes	Yes
Nominal Water		m ³ /h	1.38	2.75
Expansion Vessel	Volume	L	8	8
	Max. Water Pressure	Bar	3	3

Operation Range

Indoor Unit Cooling

	Maximum	Minimum
Indoor	32°C DB / 23°C WB	21°C DB / 15°C WB
Outdoor	52°C DB*	-10°C DB

Indoor Unit Heating

	Maximum	Minimum
Indoor	27°C DB	15°C DB
Outdoor	16.5°C WB	-25°C WB**

Water Module Cooling

	Maximum	Minimum
Inlet Water	25°C	10°C
Outdoor	48°C DB	10°C DB

Water Module Heating (Floor Heating)

	Maximum	Minimum
Inlet Water	54°C	10°C
Outdoor	16.5°C WB	-25°C WB**

Water Module Heating (DHW)

	Maximum	Minimum
Inlet Water	54°C	10°C
Outdoor	43°C WB	-25°C WB**

DB: Dry Bulb
WB: Wet Bulb
(*): 48°C DB ~ 52°C DB, Operation Control Range
(**): -20°C WB ~ -25°C WB, Operation Control Range



INDOOR UNIT

INDOOR UNIT SPECIFICATIONS

- 4-Way Cassette Type
- Mini 4-Way Cassette Type
- Ceiling Ducted Type(AC Low-height)
- Ceiling Ducted Type(DC Low-height)
- Ceiling Ducted Type(High Static Pressure)
- Ceiling Ducted Type(Low Static Pressure)
- 1-Way Cassette Type
- 2-Way Cassette Type
- Console Type
- Wall Mounted Type
- Ceiling & Floor Type
- Floor Concealed Type
- All Fresh Air Indoor Unit
- AHU Connection KIT



INDOOR UNIT

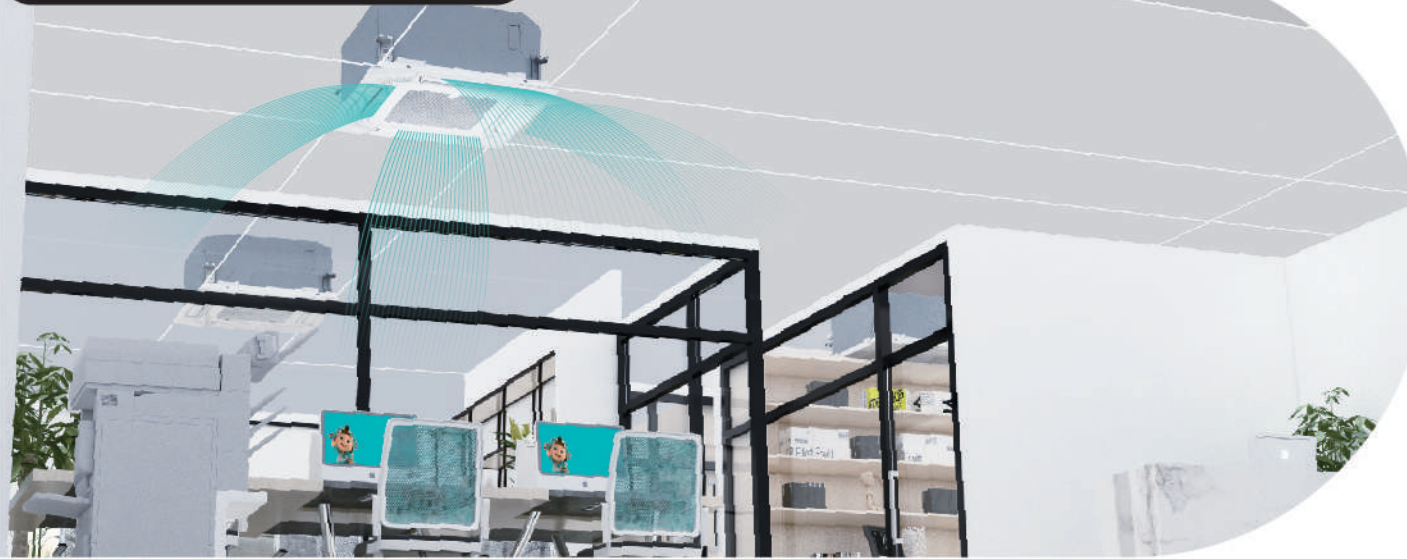

Independent louvers control

All 4 louvers on the cassette units can be adjusted independently in any 8 positions from 0° (closed) to 65° for more precise airflow direction, maximizing user's comfort and adapting to various space layouts.

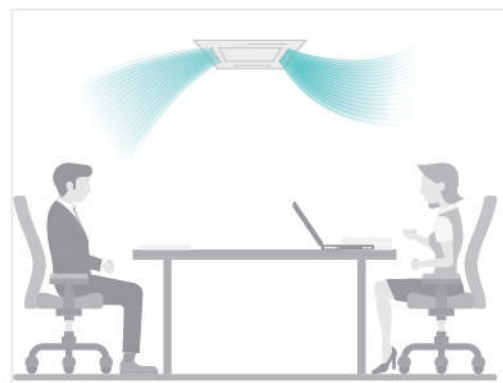
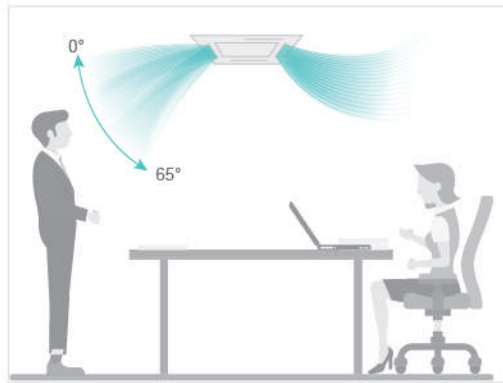

Fresh air intake

In order to satisfy the fresh air intake function, the duct adapter as the optional part equips at the mini 4-way cassette type and 4-way cassette type.

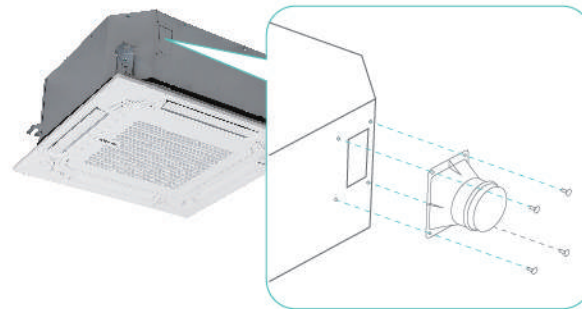

Humidity sensor(optional)

Automatic dehumidification can be achieved by choosing humidity sensor, setting humidity range from 35% to 90% and adjusting 1% accuracy.

4-way Cassette Type



Mini 4-way Cassette Type



Motion sensor (optional)

The indoor unit will automatically set through Motion Sensor.

NOTE: These functions can be achieved by the wired controllers: HYXE-J01H, HYXE-VA01, HYXM-VB01, HYXE-M01H

Standard equipped drain pump

Standard equipped drain pump with the maximum drainage height up to 1200mm.

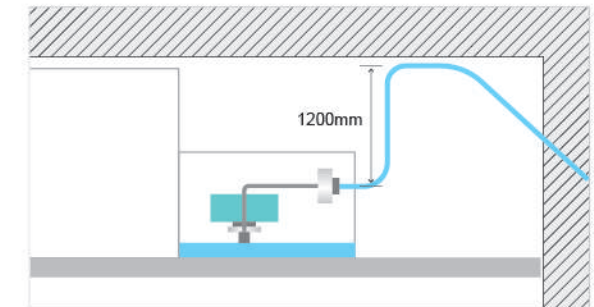

Breeze mode

Spare from feeling blown away from direct air gushing towards your face or body with the new cutting edge breezy air technology. Keep indoors cool or warm from the miniature openings on the edges.



INDOOR UNIT

4-way Cassette Type



Mini 4-way Cassette Type



Model		AVBC-09 HJFKA	AVBC-12 HJFKA	AVBC-15 HJFKA	AVBC-19 HJFKA	AVBC-22 HJFKA	AVBC-24 HJFKA	AVBC-27 HJFKA	AVBC-30 HJFKA	AVBC-38 HJFKA	AVBC-48 HJFKA	AVBC-54 HJFKA	
Power Supply		AC 1Φ, 220~240V/50Hz/60Hz											
Capacity	Cooling	kW	2.8	3.6	4.5	5.6	6.3	7.1	8.0	9.0	11.2	14.0	16.0
		Btu/h	9,600	12,300	15,400	19,100	21,500	24,200	27,300	30,700	38,200	47,800	54,600
	Heating	kW	3.2	4.0	5.0	6.3	7.1	8.0	9.0	10.0	12.5	16.0	18.0
		Btu/h	9,900	13,600	17,100	21,500	24,200	27,300	30,700	34,100	42,700	54,600	61,400
Power Input	Cooling	W	14	24	24	34	54	64	54	54	124	124	124
	Heating	W	14	24	24	34	54	64	54	54	124	124	124
Sound Pressure		dB(A)	30/28/28/ 27/26/26	32/29/29/ 28/27/26	33/31/29/ 29/27/26	34/31/30/ 28/28/26	36/33/32/ 31/29/28	36/33/32/ 31/29/28	37/36/35/ 33/31/30	37/36/35/ 33/31/30	42/40/38/ 36/34/33	46/44/40/ 38/36/34	46/44/41/ 40/38/36
			14.6/13.4/ 10.0/8.8	16.5/14.0/ 10.8/9.1	20.2/16.0/ 12.7/11.2	22.0/17.5/ 13.6/12.5	25.5/20.0/ 15.1/13.0	26.7/21.0/ 16.3/14.7	26.2/22.0/ 19.1/18.0	26.2/23.0/ 20.3/18.7	36.0/30.0/ 20.7/19.6	36.1/33.5/ 27.4/24.8	36.1/34.0/ 29.6/27.2
Airflow Rate		m ³ /min	12.0/10.8/ 10.0/8.8	12.8/11.8/ 10.8/9.1	14.9/13.6/ 12.7/11.2	15.9/15.5/ 13.6/12.5	18.3/17.0/ 15.1/13.0	19.1/18.0/ 16.3/14.7	20.3/18.7/ 17.7/16.1	20.7/19.6/ 17.7/16.1	27.4/24.8/ 22.4/19.6	29.6/27.2/ 24.5/22.4	30.7/28.9/ 25.6/23.8
	Connection Type	-	Flare-nut Connection(with Flare Nuts)										
Piping	Liquid	mm	Φ6.35	Φ6.35	Φ6.35	Φ6.35	Φ6.35	Φ9.53	Φ9.53	Φ9.53	Φ9.53	Φ9.53	Φ9.53
		inch	1/4	1/4	1/4	1/4	1/4	3/8	3/8	3/8	3/8	3/8	3/8
	Gas	mm	Φ12.7	Φ12.7	Φ12.7	Φ12.7	Φ12.7	Φ15.88	Φ15.88	Φ15.88	Φ15.88	Φ15.88	Φ15.88
		inch	1/2	1/2	1/2	1/2	1/2	5/8	5/8	5/8	5/8	5/8	5/8
Condensate Drain	mm	O.D.32											
Weight	Net Weight	kg	20	20	21	21	23	23	26	26	26	26	26
	Gross Weight	kg	24	24	25	25	27	27	31	31	31	31	31
Dimensions	External	H mm	238	238	238	238	238	238	288	288	288	288	288
		W mm	840	840	840	840	840	840	840	840	840	840	840
		D mm	840	840	840	840	840	840	840	840	840	840	840
	Packaging	H mm	292	292	292	292	292	292	342	342	342	342	342
		W mm	945	945	945	945	945	945	945	945	945	945	945
		D mm	945	945	945	945	945	945	945	945	945	945	945
Model	-	HP-G-NK	HP-G-NK	HP-G-NK	HP-G-NK	HP-G-NK	HP-G-NK	HP-G-NK	HP-G-NK	HP-G-NK	HP-G-NK	HP-G-NK	
Panel Colour	-	Neutral White											
Decoration Panel	Body Dimensions	H mm	47	47	47	47	47	47	47	47	47	47	47
		W mm	950	950	950	950	950	950	950	950	950	950	950
		D mm	950	950	950	950	950	950	950	950	950	950	950
	Packaging Dimensions	H mm	105	105	105	105	105	105	105	105	105	105	105
		W mm	1014	1014	1014	1014	1014	1014	1014	1014	1014	1014	1014
		D mm	1014	1014	1014	1014	1014	1014	1014	1014	1014	1014	1014
Net Weight	kg	5.7	5.7	5.7	5.7	5.7	5.7	5.7	5.7	5.7	5.7	5.7	
Gross Weight	kg	8	8	8	8	8	8	8	8	8	8	8	

NOTES:

- The nominal cooling capacity and heating capacity are based on following conditions:
Cooling Operation Conditions
Indoor Air Inlet Temperature:27°C DB(80°F DB),19.0°C WB(66.2°F WB)
Outdoor Air Inlet Temperature:35°C DB(95°F DB)
Piping Length:7.5 Meters Piping Lift:0 Meter
Heating Operation Conditions
Indoor Air Inlet Temperature:20°C DB(68°F DB)
Outdoor Air Inlet Temperature:7°C DB(45°F DB),6°C WB(43°F WB)

- The sound pressure level is based on following conditions:1.5m beneath the unit.
The above data was measured in an anechoic chamber so that reflected sound should be taken into consideration in the field.

Model		AVC-05HJFA	AVC-07HJFA	AVC-09HJFA	AVC-12HJFA	AVC-15HJFA	AVC-17HJFA	AVC-19HJFA	
Power Supply		AC 1Φ, 220~240V/50Hz/60Hz							
Capacity	Cooling	kW	1.5	2.2	2.8	3.6	4.5	5.0	5.6
		Btu/h	5,100	7,480	9,520	12,240	15,300	17,000	19,040
	Heating	kW	2.0	2.5	3.3	4.2	5.0	5.6	6.3
		Btu/h	6,800	8,500	11,220	14,280	17,000	19,040	21,420
Power Input	Cooling	W	80	80	80	80	80	80	80
	Heating	W	80	80	80	80	80	80	80
Sound Pressure	dB(A)	30/29/28/26	30/29/28/26	32/30/28/26	34/32/29/26	38/36/31/28	42/39/36/31	45/42/38/34	
Airflow Rate	m ³ /min	7.2/6.5/6.2/5.6	7.2/6.5/6.2/5.6	7.8/7.2/6.5/5.8	8.2/7.2/6.5/5.8	9.3/8.7/7.1/6.7	11.0/9.5/8.7/7.1	12.5/10.8/9.3/8.0	
Piping	Connection Type	-	Flare-nut Connection(with Flare Nuts)						
	Liquid	mm	Φ6.35	Φ6.35	Φ6.35	Φ6.35	Φ6.35	Φ6.35	Φ6.35
		inch	1/4	1/4	1/4	1/4	1/4	1/4	1/4
	Gas	mm	Φ12.7	Φ12.7	Φ12.7	Φ12.7	Φ12.7	Φ12.7	Φ12.7
inch		1/2	1/2	1/2	1/2	1/2	1/2	1/2	
Condensate Drain	mm	O.D.32							
Weight	Net Weight	kg	14.5	14.5	14.8	14.8	15.8	15.8	15.8
	Gross Weight	kg	17.3	17.3	17.6	17.6	18.6	18.6	18.6
Dimensions	External	H mm	215	215	215	215	215	215	215
		W mm	570	570	570	570	570	570	570
		D mm	570	570	570	570	570	570	570
	Packaging	H mm	292	292	292	292	292	292	292
		W mm	668	668	668	668	668	668	668
		D mm	730	730	730	730	730	730	730
Model	-	HPE-D-NK	HPE-D-NK	HPE-D-NK	HPE-D-NK	HPE-D-NK	HPE-D-NK	HPE-D-NK	
Panel Colour	-	Neutral White							
Decoration Panel	Body Dimensions	H mm	37	37	37	37	37	37	37
		W mm	620	620	620	620	620	620	620
		D mm	620	620	620	620	620	620	620
	Packaging Dimensions	H mm	115	115	115	115	115	115	115
		W mm	680	680	680	680	680	680	680
		D mm	690	690	690	690	690	690	690
Net Weight	kg	2.7	2.7	2.7	2.7	2.7	2.7	2.7	
Gross Weight	kg	4.5	4.5	4.5	4.5	4.5	4.5	4.5	

NOTES:

- The nominal cooling capacity and heating capacity are based on following conditions:
Cooling Operation Conditions
Indoor Air Inlet Temperature:27°C DB(80°F DB),19.0°C WB(66.2°F WB)
Outdoor Air Inlet Temperature:35°C DB(95°F DB)
Piping Length:7.5 Meters Piping Lift:0 Meter
Heating Operation Conditions
Indoor Air Inlet Temperature:20°C DB(68°F DB)
Outdoor Air Inlet Temperature:7°C DB(45°F DB),6°C WB(43°F WB)

- The sound pressure level is based on following conditions:1.5m beneath the unit.
The above data was measured in an anechoic chamber so that reflected sound should be taken into consideration in the field.

INDOOR UNIT



Adjustable static pressure

Static pressures in free supply applications would create unnecessary air-blowing noises. Hence, the fan's static pressure is made adjustable to suit different applications more precisely with smaller steps.

NOTE: DC Low-height and High Static Pressure have different static pressure choices. Please refer to the specifications for more detail information.

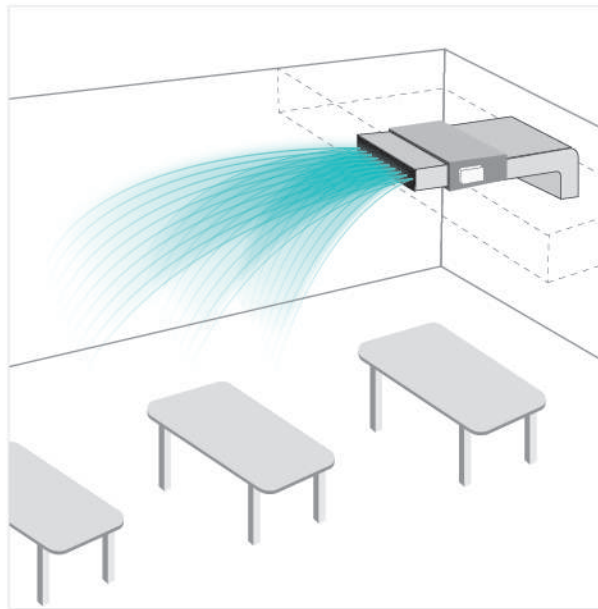

Flexible installation

Free air introduction and air filter keep the indoor air clean.

NOTE: When bottom air inlet is adopted, sound pressure will increase according to factors such as installation mode and the room structure.

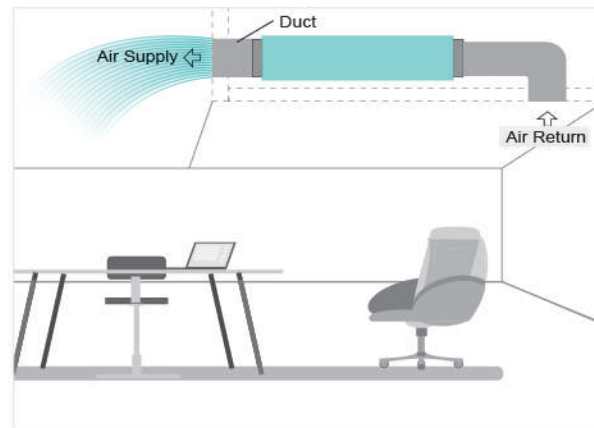

3D-airflow

The 3D louvers on the panel offers wide air flow coverage to keep every corners of your room cool or warm in any seasons of the year.

NOTE: 3D-Airflow Panel is an optional accessory only for DC Low-height. For more information please refer to Hisense engineers.

Ceiling Ducted Type

AC Low-height
DC Low-height



High Static Pressure
Low Static Pressure

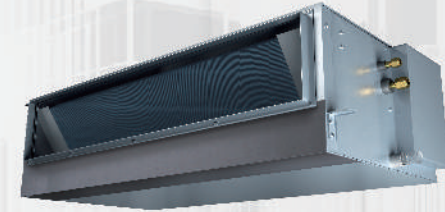

Enjoy comfortable

To prevent the human height area of the room cools or warms to user's ideal temperature setting. Triple Temperature Sensor Control Technology is integrated into the unit whereby the controller, indoor unit supply and return section consist of built in temperature sensors to send real-time signals to the unit for a more precise supplying temperature.

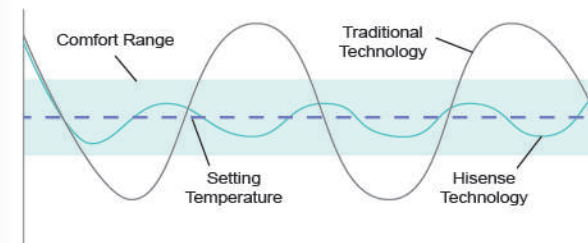

Standard equipped drain pump

Standard equipped drain pump with the maximum drainage height up to 1200mm.

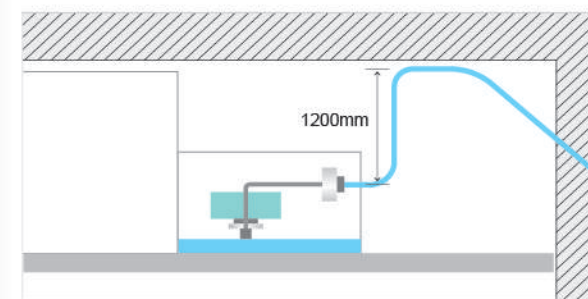

Various device connection

Third party devices and sensors to control the power supply is possible with dry contact connections to the indoor unit. Devices like Hotel room key card, window contact and fire alarms can be connected simultaneously.

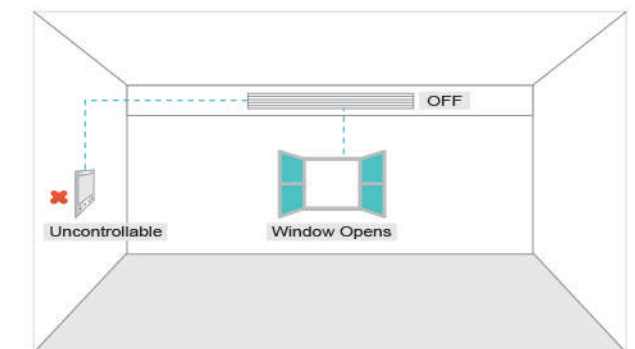
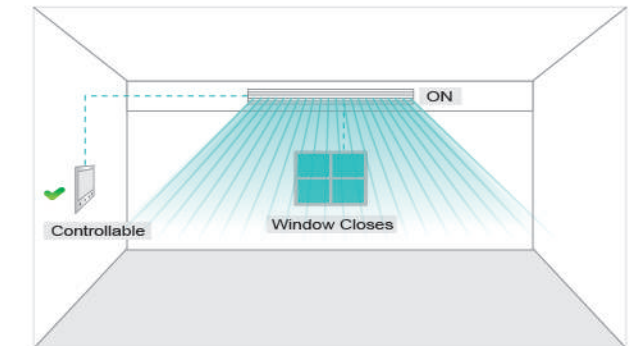

INDOOR UNIT

Ceiling Ducted Type

AC Low-height



Ceiling Ducted Type

DC Low-height



Model		AVE-05 HCFRL	AVE-07 HCFRL	AVE-09 HCFRL	AVE-12 HCFRL	AVE-15 HCFRL	AVE-17 HCFRL	AVE-19 HCFRL	AVE-22 HCFRL	AVE-24 HCFRL	
Power Supply		AC 1Φ, 220V~240V/50Hz									
Capacity	Cooling	kW	1.7	2.2	2.8	3.6	4.5	5.0	5.6	6.3	7.1
		Btu/h	5,800	7,500	9,600	12,300	15,300	17,100	19,100	21,500	24,200
Capacity	Heating	kW	1.9	2.5	3.2	4.0	5.0	5.6	6.3	7.1	8.0
		Btu/h	6,500	8,500	11,300	13,600	17,100	19,100	21,500	24,200	27,300
Power Input	Cooling	W	50	50	70	70	80	80	100	120	120
	Heating	W	50	50	70	70	80	80	100	120	120
Sound Pressure	dB(A)	29/24/22	29/24/22	35/25/23	35/25/23	36/25/23	36/25/23	35/25/23	39/26/25	39/26/25	
Airflow Rate	m ³ /min	7/5.5/4.7	7/5.5/4.7	9/5.7/4.8	9/5.7/4.8	12/6.3/5.5	12/6.3/5.5	13.5/8/7.7	18/9.3/8.7	18/9.3/8.7	
External Static Pressure	Pa	10(30)	10(30)	10(30)	10(30)	10(30)	10(30)	10(30)	10(30)	10(30)	
Piping	Connection Type	-	Flare-nut Connection(with Flare Nuts)								
	Liquid	mm	Φ 6.35	Φ 6.35	Φ 6.35	Φ 6.35	Φ 6.35	Φ 6.35	Φ 6.35	Φ 9.53	Φ 9.53
		inch	1/4	1/4	1/4	1/4	1/4	1/4	1/4	3/8	3/8
	Gas	mm	Φ 12.7	Φ 12.7	Φ 12.7	Φ 12.7	Φ 12.7	Φ 12.7	Φ 15.88	Φ 15.88	Φ 15.88
		inch	1/2	1/2	1/2	1/2	1/2	1/2	5/8	5/8	5/8
Condensate Drain	mm	O.D.32									
Weight	Net Weight	kg	16	16	17	17	21	21	25	26	26
	Gross Weight	kg	19	19	20	20	24	24	29	29	29
Dimensions	External	H mm	192	192	192	192	192	192	192	192	192
		W mm	700	700	700	700	910	910	1180	1180	1180
		D mm	447	447	447	447	447	447	447	447	447
	Packaging	H mm	270	270	270	270	270	270	270	270	270
		W mm	925	925	925	925	1136	1136	1406	1406	1406
	D mm	574	574	574	574	574	574	574	574	574	

Model		AVE-05 HJFDL	AVE-07 HJFDL	AVE-09 HJFDL	AVE-12 HJFDL	AVE-15 HJFDL	AVE-17 HJFDL	AVE-19 HJFDL	AVE-22 HJFDL	AVE-24 HJFDL	
Power Supply		AC 1Φ, 220V~240V/50Hz/60Hz									
Capacity	Cooling	kW	1.7	2.2	2.8	3.6	4.5	5.0	5.6	6.3	7.1
		Btu/h	5,800	7,500	9,600	12,300	15,300	17,100	19,100	21,500	24,200
Capacity	Heating	kW	1.9	2.5	3.2	4.0	5.0	5.6	6.3	7.1	8.0
		Btu/h	6,500	8,500	11,300	13,600	17,100	19,100	21,500	24,200	27,300
Power Input	Cooling	W	30	30	50	50	60	60	60	90	90
	Heating	W	30	30	50	50	60	60	60	90	90
Sound Pressure	dB(A)	28/27/26/ 24/23/21	28/27/26/ 24/23/21	35/32/32/ 30/26/23	35/32/32/ 30/26/23	35/32/32/ 30/26/23	35/32/32/ 30/26/23	35/32/30/ 28/25/23	38/36/35/ 33/31/24	38/36/35/ 33/31/24	
Airflow Rate	m ³ /min	7.0/6.5/6.1/ 5.7/5.3/4.8	7.0/6.5/6.1/ 5.7/5.3/4.8	9.0/8.1/7.3/ 6.7/5.9/5.2	9.0/8.1/7.3/ 6.7/5.9/5.2	12/10.8/9.4/ 8.1/6.8/5.5	12/10.8/9.4/ 8.1/6.8/5.5	13.5/12.5/11.2/ 10.0/8.8/7.7	18/16.1/14.3/ 12.3/10.5/8.7	18/16.1/14.3/ 12.3/10.5/8.7	
External Static Pressure	Pa	10(0-10-30)	10(0-10-30)	10(0-10-30)	10(0-10-30)	10(0-10-30)	10(0-10-30)	10(0-10-30)	10(0-10-30)	10(0-10-30)	
Piping	Connection Type	-	Flare-nut Connection(with Flare Nuts)								
	Liquid	mm	Φ 6.35	Φ 6.35	Φ 6.35	Φ 6.35	Φ 6.35	Φ 6.35	Φ 6.35	Φ 9.53	Φ 9.53
		inch	1/4	1/4	1/4	1/4	1/4	1/4	1/4	3/8	3/8
	Gas	mm	Φ 12.7	Φ 12.7	Φ 12.7	Φ 12.7	Φ 12.7	Φ 12.7	Φ 15.88	Φ 15.88	Φ 15.88
		inch	1/2	1/2	1/2	1/2	1/2	1/2	5/8	5/8	5/8
Condensate Drain	mm	O.D.32									
Weight	Net Weight	kg	16	16	17	17	20	20	24	24	24
	Gross Weight	kg	19	19	20	20	24	24	29	29	29
Dimensions	External	H mm	192	192	192	192	192	192	192	192	192
		W mm	700	700	700	700	910	910	1180	1180	1180
		D mm	447	447	447	447	447	447	447	447	447
	Packaging	H mm	270	270	270	270	270	270	270	270	270
		W mm	925	925	925	925	1136	1136	1406	1406	1406
	D mm	574	574	574	574	574	574	574	574	574	

NOTES:

- The nominal cooling capacity and heating capacity are based on the following conditions:
Cooling Operation Conditions
Indoor Air Inlet Temperature: 27°C DB(80°F DB), 19.0°C WB(66.2°F WB)
Outdoor Air Inlet Temperature: 35°C DB(95°F DB)
Piping Length: 7.5 Meters Piping Lift: 0 Meter
Heating Operation Conditions
Indoor Air Inlet Temperature: 20°C DB(68°F DB)
Outdoor Air Inlet Temperature: 7°C DB(45°F DB), 6°C WB(43°F WB)
- The sound pressure level is based on the following conditions: 1.5m beneath the unit.
The above data was measured in an anechoic chamber so that the reflected sound should be taken into consideration in the field.

NOTES:

- The nominal cooling capacity and heating capacity are based on the following conditions:
Cooling Operation Conditions
Indoor Air Inlet Temperature: 27°C DB(80°F DB), 19.0°C WB(66.2°F WB)
Outdoor Air Inlet Temperature: 35°C DB(95°F DB)
Piping Length: 7.5 Meters Piping Lift: 0 Meter
Heating Operation Conditions
Indoor Air Inlet Temperature: 20°C DB(68°F DB)
Outdoor Air Inlet Temperature: 7°C DB(45°F DB), 6°C WB(43°F WB)
- The sound pressure level is based on the following conditions: 1.5m beneath the unit.
The above data was measured in an anechoic chamber so that the reflected sound should be taken into consideration in the field.

INDOOR UNIT

Ceiling Ducted Type High Static Pressure



Ceiling Ducted Type Low Static Pressure

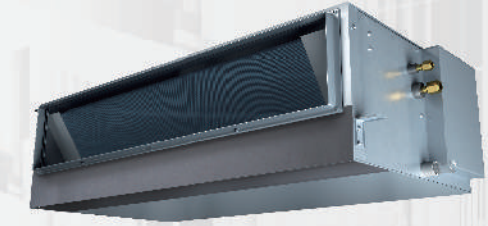

Model	AVD-07 HCFCH	AVD-09 HCFCH	AVD-12 HCFCH	AVD-15 HCFCH	AVD-19 HCFCH	AVD-22 HCFCH	AVD-24 HCFCH	AVD-27 HCFCH	AVD-30 HCFCH	AVD-38 HCFCH	AVD-48 HCFCH	AVD-54 HCFCH	AVD-76U X6SEH*1	AVD-96U X6SFH*1		
Power Supply	AC 1Φ, 220V~240V/50Hz															
Model	AVD-07 H3FCH	AVD-09 H3FCH	AVD-12 H3FCH	AVD-15 H3FCH	AVD-19 H3FCH	AVD-22 H3FCH	AVD-24 H3FCH	AVD-27 H3FCH	AVD-30 H3FCH	AVD-38 H3FCH	AVD-48 H3FCH	AVD-54 H3FCH	—	—		
Power Supply	AC 1Φ, 208~230V/60Hz															
Capacity	Cooling	kW	2.2	2.8	3.6	4.5	5.6	6.3	7.1	8.0	9.0	11.2	14.0	16.0	22.4	28.0
	Heating	kW	2.5	3.2	4.0	5.0	6.3	7.1	8.0	9.0	10.0	12.5	16.0	18.0	25	31.5
Power Input	Cooling	kW	0.10(0.13*)	0.10(0.13*)	0.13(0.16*)	0.13(0.16*)	0.14(0.21*)	0.19(0.24*)	0.19(0.24*)	0.25(0.34*)	0.25(0.34*)	0.25(0.34*)	0.34(0.45*)	0.43(0.59*)	1.03	1.28
	Heating	kW	0.10(0.13*)	0.10(0.13*)	0.13(0.16*)	0.13(0.16*)	0.14(0.21*)	0.19(0.24*)	0.19(0.24*)	0.25(0.34*)	0.25(0.34*)	0.25(0.34*)	0.34(0.45*)	0.43(0.59*)	1.03	1.28
Sound Pressure	220-240V/50Hz	dB(A)	32/27/25	32/27/25	35/32/26	35/32/26	36/35/30	39/32/25	39/32/25	42/39/34	42/39/34	42/39/34	43/40/35	46/40/35	52	54
	208V/60Hz	dB(A)	33/28/24	33/28/24	37/34/29	37/34/29	37/35/29	39/32/25	39/32/25	42/38/33	42/38/33	42/38/33	44/39/34	45/40/34	52	54
	230V/60Hz	dB(A)	37/33/28	37/33/28	40/38/33	40/38/33	42/40/34	43/37/30	43/37/30	44/42/37	44/42/37	44/42/37	47/43/38	46/42/38	52	54
Air Flow(Hi/Me/Lo)	m³/h	9/7/6	9/7/6	12/10/8.5	12/10/8.5	15/13/10	19/14/10	19/14/10	28/24/19.5	28/24/19.5	28/24/19.5	35.5/29/24	39/31/24	58	77.5	
External Static Pressure	220-240V/50Hz	Pa	50(80)	50(80)	50(80)	50(80)	50(80)	50(80)	120(90)	120(90)	120(90)	120(90)	120(90)	220	220	
	230V/60Hz	Pa	80(105)	80(105)	90(115)	90(115)	90(115)	90(115)	170(150)	170(150)	170(150)	170(150)	170(150)	-	-	
Piping	Connection Type	-	Flare-nut Connection(with Flare Nuts)											Brazing		
	Liquid	mm	Φ6.35	Φ6.35	Φ6.35	Φ6.35	Φ6.35	Φ9.53	Φ9.53	Φ9.53	Φ9.53	Φ9.53	Φ9.53	Φ9.53	Φ9.53	Φ9.53
	Gas	mm	Φ12.7	Φ12.7	Φ12.7	Φ12.7	Φ15.88	Φ15.88	Φ15.88	Φ15.88	Φ15.88	Φ19.05	Φ19.05	Φ19.05	Φ19.05	Φ22.2
	Condensate Drain	mm	O.D.32													
	Weight	kg	25(24*)	25(24*)	25(24*)	25(24*)	30(31*)	30(31*)	30(31*)	45(44*)	45(44*)	45(44*)	53(50*)	53(50*)	94	106
Dimensions	Net Weight	kg	31(30*)	31(30*)	31(30*)	31(30*)	36(38*)	37(38*)	37(38*)	52(52*)	52(52*)	52(52*)	61(59*)	61(59*)	106	111
	Gross Weight	kg	31(30*)	31(30*)	31(30*)	31(30*)	36(38*)	37(38*)	37(38*)	52(52*)	52(52*)	52(52*)	61(59*)	61(59*)	106	111
	External H	mm	270	270	270	270	270	270	270	300	300	300	300	300	470	470
	External W	mm	650+75	650+75	650+75	650+75	900+75	900+75	900+75	1100+75	1100+75	1100+75	1400+75	1400+75	1060	1250
	Packaging W	mm	895	895	895	895	1140	1140	1140	1345	1345	1345	1640	1640	1276	1466
Packaging D	mm	870	870	870	870	870	870	870	950	950	950	950	950	546	546	

NOTES:
 1. The nominal cooling capacity and heating capacity are based on the following conditions:
 Cooling Operation Conditions
 Indoor Air Inlet Temperature: 27°C DB(80°F DB), 19.0°C WB(66.2°F WB)
 Outdoor Air Inlet Temperature: 35°C DB(95°F DB)
 Piping Length: 7.5 Meters Piping Lift: 0 Meter
 Heating Operation Conditions
 Indoor Air Inlet Temperature: 20°C DB(68°F DB)
 Outdoor Air Inlet Temperature: 7°C DB(45°F DB), 6°C WB(43°F WB)

2. The sound pressure level is based on the following conditions: 1.5m beneath the unit. With discharge duct (2.0m) and return duct(1.0m)
 The above data was measured in an anechoic chamber so that the reflected sound should be taken into consideration in the field.
 3. When bottom air inlet is adopted, the sound pressure will increase according to factors such as installation mode and the room structure.
 *1: AC 3Φ, 380V/50Hz, *2: The value noted *2 is the parameter of the indoor units with power supply 208~230V/60Hz.

Model	AVD-07 HCFCL	AVD-09 HCFCL	AVD-12 HCFCL	AVD-15 HCFCL	AVD-19 HCFCL	AVD-22 HCFCL	AVD-24 HCFCL	AVD-27 HCFCL	AVD-30 HCFCL	AVD-38 HCFCL	AVD-48 HCFCL	AVD-54 HCFCL	AVD-76U X6SEL*1	AVD-96U X6SFL*1		
Power Supply	AC 1Φ, 220V~240V/50Hz															
Capacity	Cooling	kW	2.2	2.8	3.6	4.5	5.6	6.3	7.1	8.0	9.0	11.2	14.0	16.0	22.4	28.0
	Heating	kW	2.5	3.2	4.0	5.0	6.3	6.5	7.3	8.7	9.3	11.6	14.5	16.5	25.0	31.5
Power Input	Cooling	W	60	60	110	110	90	160	160	240	240	240	290	360	950	1120
	Heating	W	60	60	110	110	90	160	160	240	240	240	290	360	950	1120
Sound Pressure	dB(A)	27/23/21	27/23/21	34/30/25	34/30/25	32/30/26	35/28/24	35/28/24	38/33/30	38/33/30	38/33/30	41/38/33	44/39/33	50	52	
Air Flow Rate (Hi/Me/Lo)	m³/h	9/7/6	9/7/6	12/10/8.5	12/10/8.5	15/13/10	19/14/10	19/14/10	28/24/19.5	28/24/19.5	28/24/19.5	35.5/29/24	39/31/24	58	72	
External Static Pressure	Pa	30	30	30	30	30	30	30	60	60	60	60	60	100	100	
	Connection Type	-	Flare-nut Connection(with Flare Nuts)											Brazing		
Piping	Liquid	mm	Φ6.35	Φ6.35	Φ6.35	Φ6.35	Φ6.35	Φ9.53	Φ9.53	Φ9.53	Φ9.53	Φ9.53	Φ9.53	Φ9.53	Φ9.53	
	Gas	mm	Φ12.7	Φ12.7	Φ12.7	Φ12.7	Φ15.88	Φ15.88	Φ15.88	Φ15.88	Φ15.88	Φ19.05	Φ19.05	Φ19.05	Φ22.2	
	Condensate Drain	mm	O.D.32													
Weight	Net Weight	kg	25	25	25	25	30	30	30	45	45	45	52	52	94	106
	Gross Weight	kg	31	31	31	31	36	37	37	52	52	52	61	61	106	111
Dimensions	External H	mm	270	270	270	270	270	270	300	300	300	300	300	470	470	
	External W	mm	650+75	650+75	650+75	650+75	900+75	900+75	900+75	1100+75	1100+75	1100+75	1400+75	1400+75	1060	1250
	Packaging W	mm	895	895	895	895	1140	1140	1140	1345	1345	1345	1640	1640	1276	1466
	Packaging D	mm	870	870	870	870	870	870	870	950	950	950	950	950	546	546

NOTES:
 1. The nominal cooling capacity and heating capacity are based on the following conditions:
 Cooling Operation Conditions
 Indoor Air Inlet Temperature: 27°C DB(80°F DB), 19.0°C WB(66.2°F WB)
 Outdoor Air Inlet Temperature: 35°C DB(95°F DB)
 Piping Length: 7.5 Meters Piping Lift: 0 Meter
 Heating Operation Conditions
 Indoor Air Inlet Temperature: 20°C DB(68°F DB)
 Outdoor Air Inlet Temperature: 7°C DB(45°F DB), 6°C WB(43°F WB)
 2. The sound pressure level is based on the following conditions: 1.5m beneath the unit. With discharge duct (2.0m) and return duct(1.0m)
 The above data was measured in an anechoic chamber so that the reflected sound should be taken into consideration in the field.
 3. When bottom air inlet is adopted, the sound pressure will increase according to factors such as installation mode and the room structure.
 *1: AC 3Φ, 380V/50Hz

INDOOR UNIT



Convenient installation

Customers can choose the installation method according to different situation. The concise fashion elements style is suitable for renewal projects and un-decorated shopping malls or classrooms.

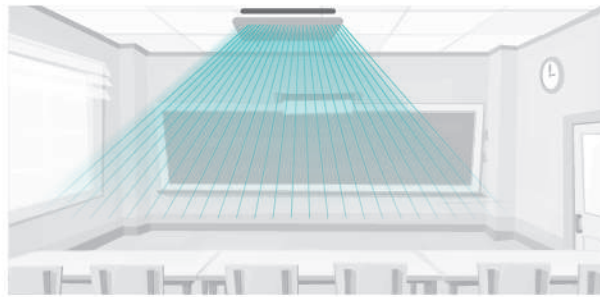

Efficiency DC motor

Adoption of the efficient DC motor and the optimized duct design assure the smooth air flow.

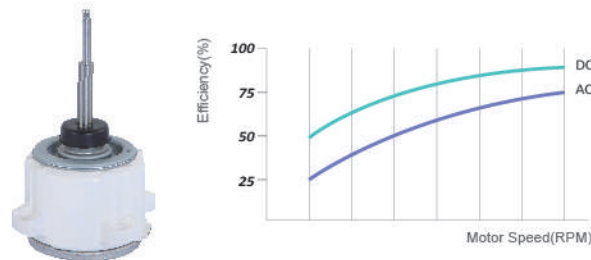

Wider 3D-airflow range

Broad air deflector design realizes broad air supply range. The wind direction can be adjusted according to the need thus it can make the customers feel more comfortable.

NOTE: This function can be achieved by the wired controller: HYXE-J01H, HYXE-VA01, HYXM-VB01, HYXE-M01H

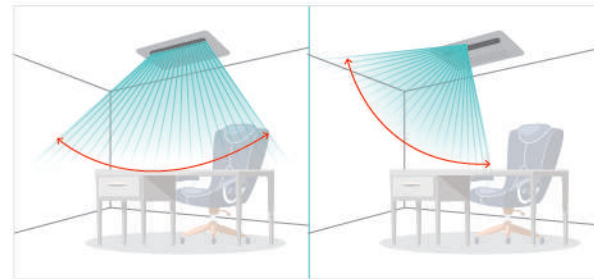

Standard equipped drain pump

Standard equipped drain pump with the maximum drainage height up to 1200mm.

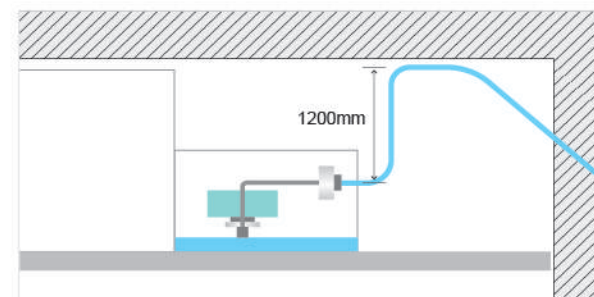

1-way Cassette Type



Model		AVY-07UXISJA	AVY-09UXISJA	AVY-12UXISJA	AVY-14UXISJA	AVY-18UXISKA	AVY-24UXISKA	
Power Supply		AC 1Φ, 220~240V/50Hz/60Hz						
Capacity	Cooling	kW	2.2	2.8	3.6	4.0	5.6	7.1
		Btu/h	7,500	9,600	12,300	13,600	19,100	24,200
	Heating	kW	2.5	3.2	4.0	4.5	6.3	8.0
		Btu/h	8,500	10,900	13,600	15,400	21,500	27,300
Power Input	Cooling	W	14	14	24	34	34	74
	Heating	W	14	24	34	44	44	94
Sound Pressure	dB(A)	33/32/31/30/29/28	35/34/32/31/29/28	40/36/35/33/30/29	40/36/35/33/30/29	41/39/36/35/33/31	48/46/43/40/37/33	
Airflow Rate		m ³ /min	6.2/5.9/5.6/	6.6/6.2/5.6/	8.3/7.3/6.8/	8.3/7.3/6.8/	12.1/9.9/8.8/	15.6/12.6/11.2/
			5.1/4.8/4.6	5.1/4.8/4.6	6.2/5.6/5.1	6.2/5.6/5.1	8.2/7.8/6.6	9.9/8.4/7.1
Connection Type		Flare-nut Connection(with Flare Nuts)						
Piping	Liquid	mm	Φ6.35	Φ6.35	Φ6.35	Φ6.35	Φ6.35	Φ9.53
		inch	1/4	1/4	1/4	1/4	1/4	3/8
	Gas	mm	Φ12.7	Φ12.7	Φ12.7	Φ12.7	Φ15.88	Φ15.88
		inch	1/2	1/2	1/2	1/2	5/8	5/8
Condensate Drain	mm	O.D.32						
Weight	Net Weight	kg	19	19	20	20	24	24
	Gross Weight	kg	23	23	24	24	29	29
Dimensions	External	H mm	192	192	192	192	192	192
		W mm	910	910	910	910	1180	1180
		D mm	470	470	470	470	470	470
	Packaging	H mm	268	268	268	268	268	268
		W mm	1136	1136	1136	1136	1406	1406
		D mm	574	574	574	574	574	574
Model		HP-D-NA	HP-D-NA	HP-D-NA	HP-D-NA	HP-E-NA	HP-E-NA	
Panel Colour		Neutral White						
Decoration Panel	Body Dimensions	H mm	55	55	55	55	55	55
		W mm	1100	1100	1100	1100	1370	1370
	Packaging Dimensions	D mm	550	550	550	550	550	550
		H mm	130	130	130	130	130	130
Net Weight	W mm	1160	1160	1160	1160	1430	1430	
	D mm	610	610	610	610	610	610	
Net Weight	kg	5	5	5	5	6	6	
Gross Weight	kg	8	8	8	8	10	10	

NOTES:

1. The nominal cooling capacity is based on the following conditions:
 Indoor Air Inlet Temperature: 27°C DB (80°F DB), 19.0°C WB(66.2°F WB)
 Outdoor Air Inlet Temperature: 35°C DB(95°F DB)
 Piping Length: 7.5 Meters Piping Lift: 0 Meter

2. The sound pressure level is based on the following conditions: 1.0m beneath the unit, 1.0m from Discharge Grille. The above data was measured in an anechoic chamber so that the reflected sound should be taken into consideration in the field. When bottom air inlet is adopted, the sound pressure will increase according to factors such as installation mode and the room structure.

INDOOR UNIT



2-way Cassette Type



2-way individual louver

The newly equipped individual louver setting function allows the angles of the 2 louvers to be adjusted individually.

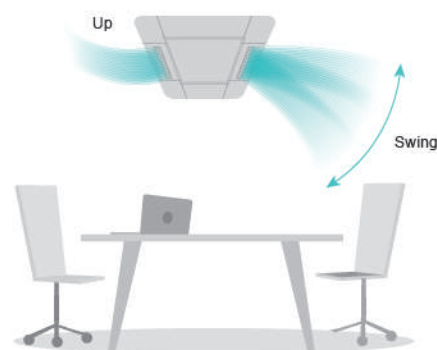

Space saving

The slim structure of the cassette having height as low as 298mm can be installed in ceiling spaces with a minimum of 310mm. Narrow corridors or zoned spaces are best fitted with 2 way cassettes due to its compact design having 1.42m.

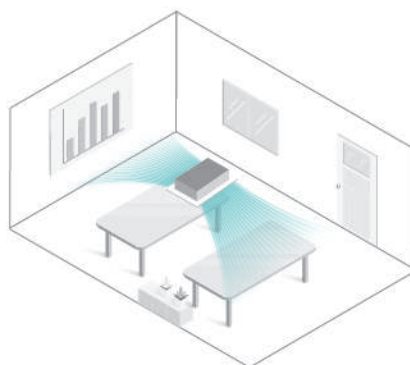

Efficiency DC motor

Adoption of the efficient DC motor and the optimized duct design assure the smooth air flow.

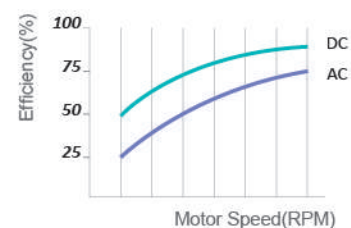

Standard equipped drain pump

Standard equipped drain pump with the maximum drainage height up to 1200mm.

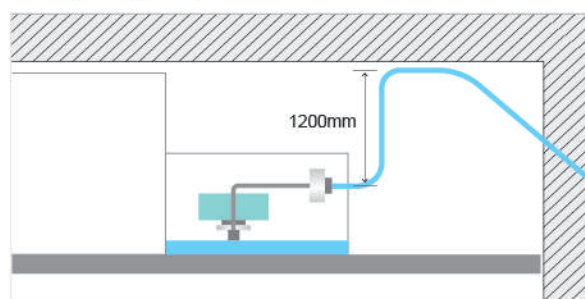

Model		AVL-07 UXJSGA	AVL-09 UXJSGA	AVL-12 UXJSGA	AVL-14 UXJSGA	AVL-18 UXJSGA	AVL-24 UXJSGA	AVL-27 UXJSGA	AVL-30 UXJSGA	AVL-38 UXJSHA	AVL-48 UXJSHA	AVL-54 UXJSHA	
Power Supply		AC 1Φ, 220~240V/50Hz/60Hz											
Capacity	Cooling	kW	2.2	2.8	3.6	4.3	5.6	7.1	8.4	9.0	11.2	14.0	16.0
		Btu/h	7,500	9,600	12,300	14,700	19,100	24,200	28,700	30,700	38,200	47,800	54,600
Power Input	Heating	kW	2.8	3.3	4.0	4.9	6.5	8.0	9.0	10.0	13.0	16.0	18.0
		Btu/h	9,600	11,300	13,600	16,700	22,200	27,300	30,700	34,100	44,400	54,600	61,400
Sound Pressure	Cooling	W	14	14	14	24	34	44	64	74	84	104	114
	Heating	W	14	14	14	24	34	44	64	74	84	104	114
Airflow Rate		dB(A)	32/30/ 29/27	33/30/ 29/28	34/31/ 30/28	40/37/ 34/32	42/39/ 36/33	45/42/ 40/36	47/44/ 40/36	49/46/ 42/37	46/44/ 40/38	48/45/ 42/38	49/46/ 43/40
		m ³ /min	10.0/8.5/ 7.2/6.0	11.0/9.4/ 8.2/6.6	12.0/10.5/ 8.9/7.5	15.0/13.2/ 11.5/9.9	17.0/14.9/ 13.0/11.2	19.0/16.4/ 14.3/12.3	21.0/18.4/ 15.6/12.6	22.0/19.3/ 16.3/13.1	30.0/26.4/ 23.1/19.8	35.0/30.8/ 26.9/21.1	37.0/32.5/ 28.4/24.1
Piping	Connection Type	-	Flare-nut Connection(with Flare Nuts)										
	Liquid	mm	Φ6.35	Φ6.35	Φ6.35	Φ6.35	Φ6.35	Φ9.53	Φ9.53	Φ9.53	Φ9.53	Φ9.53	Φ9.53
		inch	1/4	1/4	1/4	1/4	1/4	3/8	3/8	3/8	3/8	3/8	3/8
	Gas	mm	Φ12.7	Φ12.7	Φ12.7	Φ12.7	Φ15.88	Φ15.88	Φ15.88	Φ15.88	Φ15.88	Φ15.88	Φ15.88
	inch	1/2	1/2	1/2	1/2	5/8	5/8	5/8	5/8	5/8	5/8	5/8	
Weight	Condensate Drain	mm	O.D.32										
	Net Weight	kg	22	22	22	24	24	24	24	24	39	39	39
	Gross Weight	kg	28	28	28	30	30	30	30	30	47	47	47
Dimensions	External	H mm	298	298	298	298	298	298	298	298	298	298	298
		W mm	860	860	860	860	860	860	860	860	1420	1420	1420
	Packaging	D mm	630	630	630	630	630	630	630	630	630	630	630
		H mm	350	350	350	350	350	350	350	350	350	350	350
	W mm	1070	1070	1070	1070	1070	1070	1070	1070	1070	1630	1630	
	D mm	710	710	710	710	710	710	710	710	710	710	710	
Decoration Panel	Model	-	HP-C-NA	HP-C-NA	HP-C-NA	HP-C-NA	HP-C-NA	HP-C-NA	HP-C-NA	HP-C-NA	HP-F-NA	HP-F-NA	
	Panel Colour	-	Neutral White										
	Body Dimensions	H mm	30	30	30	30	30	30	30	30	30	30	30
		W mm	1100	1100	1100	1100	1100	1100	1100	1100	1100	1660	1660
		D mm	710	710	710	710	710	710	710	710	710	710	710
	Packaging Dimensions	H mm	160	160	160	160	160	160	160	160	160	160	160
		W mm	1170	1170	1170	1170	1170	1170	1170	1170	1170	1710	1710
		D mm	740	740	740	740	740	740	740	740	740	740	740
	Net Weight	kg	7.5	7.5	7.5	7.5	7.5	7.5	7.5	7.5	10.5	10.5	10.5
	Gross Weight	kg	13.3	13.3	13.3	13.3	13.3	13.3	13.3	13.3	17.8	17.8	17.8

NOTES:

1. The nominal cooling capacity is based on the following conditions:
 Indoor Air Inlet Temperature: 27°C DB (80°F DB), 19.0°C WB(66.2°F WB)
 Outdoor Air Inlet Temperature: 35°C DB(95°F DB)
 Piping Length: 7.5 Meters Piping Lift: 0 Meter

2. The sound pressure level is based on the following conditions: 1.5m beneath the unit.
 The above data was measured in an anechoic chamber so that the reflected sound should be taken into consideration in the field.

INDOOR UNIT

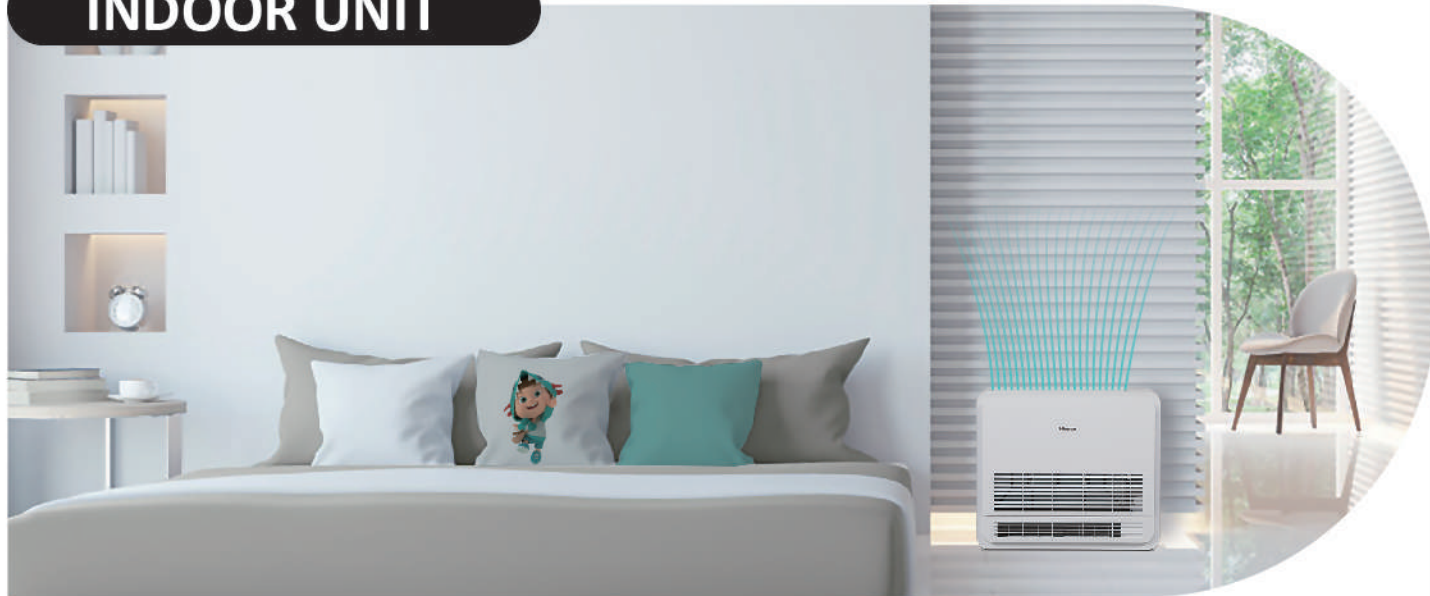

3D air supply/return

Heat Mode

When the temperature of air return exceeds 20°C, the upper air deflector will close automatically. When the temperature of air return is below 18°C, the upper air deflector will open automatically.

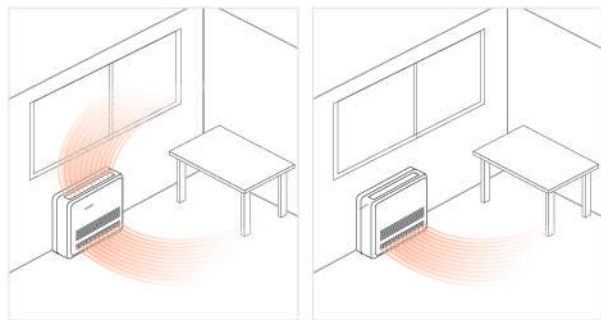

Cool Mode

After running one hour in cooling mode, the air deflector below will close automatically.

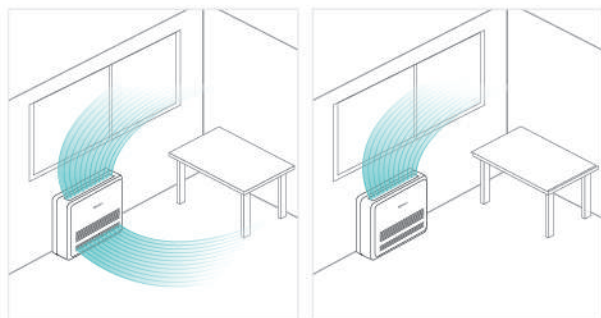

Stylish aesthetics

With LED and temperature display, console unit is an upgraded stylish air-conditioning option to the customers. Be suitable for any residential or commercial applications needed a unit near the floor for effective heating during the winter and cooling during summer.

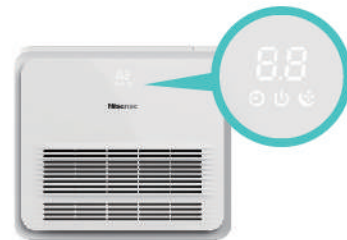

Connected with Hi-Motion

The unit can be controlled automatically through the Hi-Motion (optional).

NOTE: This function can be achieved by the wired controller: HYXE-J01H, HYXM-VB01



Console Type



Model		AVK-05HJFCAA	AVK-07HJFCAA	AVK-09HJFCAA	AVK-12HJFCAA	AVK-15HJFCAA	AVK-17HJFCAA	
Power Supply		AC 1Φ, 220V~240V/50Hz/60Hz						
Capacity	Cooling	kW	1.5	2.2	2.8	3.6	4.5	5.0
		Btu/h	5,100	7,500	9,600	12,300	15,300	17,000
Power Input	Heating	kW	2.0	2.5	3.3	4.2	5.0	5.6
		Btu/h	6,800	8,500	11,200	14,300	17,000	19,100
Sound Pressure	dB(A)	32/30/29/28/26/24	34/32/31/29/27/26	36/35/32/31/29/27	39/36/34/31/29/27	41/39/37/35/33/32	44/43/41/39/37/36	
Airflow Rate		m ³ /min	6.0/5.7/5.3/	7.4/7.0/6.4/	8.0/7.4/7.0/	8.2/7.6/6.8/	9.0/8.5/7.8/	10.1/9.7/9.0/
			5.1/4.7/4.5	6.0/5.6/5.3	6.4/6.0/5.6	6.2/5.7/5.3	7.2/6.6/6.4	8.5/7.9/7.3
Panel Colour	-	Pure White	Pure White	Pure White	Pure White	Pure White	Pure White	
Piping	Connection Type	-	Flare-nut Connection(with Flare Nuts)					
	Liquid	mm	Φ 6.35	Φ 6.35	Φ 6.35	Φ 6.35	Φ 6.35	Φ 6.35
		inch	1/4	1/4	1/4	1/4	1/4	1/4
	Gas	mm	Φ 12.7	Φ 12.7	Φ 12.7	Φ 12.7	Φ 12.7	Φ 12.7
inch		1/2	1/2	1/2	1/2	1/2	1/2	
Condensate Drain	mm	O.D.32						
Weight	Net Weight	kg	16.1	16.1	16.1	17.4	17.4	17.4
	Gross Weight	kg	20.6	21.1	21.1	21.5	21.5	21.5
Dimensions	External	H mm	630	630	630	630	630	630
		W mm	700	700	700	700	700	700
	Packaging	H mm	225	225	225	225	225	225
		W mm	790	790	790	790	790	790
	D mm	315	315	315	315	315	315	

NOTES:

1. The nominal cooling capacity and heating capacity are based on the following conditions:
 Cooling Operation Conditions
 Indoor Air Inlet Temperature: 27°C DB(80°F DB), 19.0°C WB(66.2°F WB)
 Outdoor Air Inlet Temperature: 35°C DB(95°F DB)
 Piping Length: 7.5 Meters Piping Lift: 0 Meter
 Heating Operation Conditions
 Indoor Air Inlet Temperature: 20°C DB(68°F DB)
 Outdoor Air Inlet Temperature: 7°C DB(45°F DB), 6°C WB(43°F WB)

2. The sound pressure level is based on following conditions:
 It is measured in anechoic room. Operation noise differs with operation and ambient conditions.
 Location of Microphone:

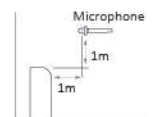

INDOOR UNIT



Wider 3D-airflow range

Broad air deflector design realizes broad air supply range. The wind direction can be adjusted according to the need thus it can make the customers feel more comfortable.

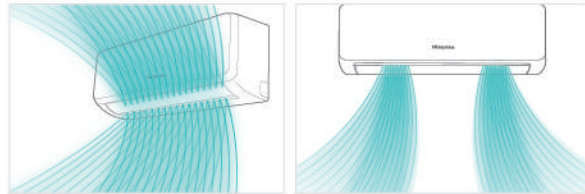

Sleek smooth design

Shiny White cover panel of the unit has an elegant aesthetic. The unit also offers LED temperature display hidden under the smooth panel and eases cleaning routine without compromising user's convenience while setting the temperature.



*The wireless remote controller HYE-W01 is standard for Wall Mounted Type.



Lighter to simplify installation

Light weighted resins composites are used for the panels, louvers and other parts to reduce overall weight per unit for a simpler installation experience.

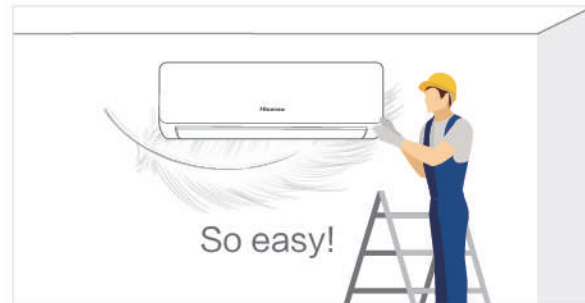

Flexible piping connection

Both Refrigerant and drainage pipings are freely to connect in any direction including any sides(L or R). An additional direction to the back of the unit for refrigerant pipes is allowed passing through walls.

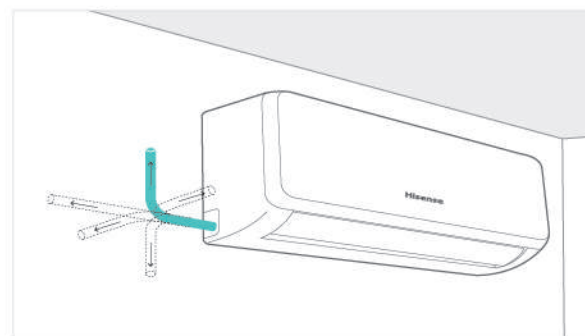

Wall Mounted Type



Model		AVS-07 URCSABA	AVS-09 URCSABA	AVS-12 URCSABA	AVS-14 URCSABA	AVS-17 URCSABA	AVS-18 URCSBBA	AVS-22 URCSBBA	AVS-24 URCSBBA	
Power Supply		AC 1Φ, 220V~240V/50Hz								
Model		AVS-07 UR2SABA	AVS-09 UR2SABA	AVS-12 UR2SABA	AVS-14 UR2SABA	AVS-17 UR2SABA	AVS-18 UR2SBBA	AVS-22 UR2SBBA	AVS-24 UR2SBBA	
Power Supply		AC 1Φ, 220V/60Hz								
Capacity	Cooling	kW	2.2	2.8	3.6	4.0	5.0	5.6	6.3	7.1
		Btu/h	7,500	9,500	12,300	13,600	17,000	19,100	21,500	24,200
Heating	kW	2.5	3.3	4.0	4.5	5.6	6.3	7.1	8.0	
	Btu/h	8,500	11,100	13,600	15,300	19,100	21,500	24,200	27,300	
Power Input	Cooling	W	50	50	60	60	65	54	62	72
	Heating	W	50	50	60	60	65	62	72	82
Sound Pressure	dB(A)	39/34/32/28	39/34/32/28	43/39/32/28	43/39/32/28	45/40/34/29	41/37/34/30	44/41/36/31	46/43/38/33	
Airflow Rate	m ³ /min	11.0/9.8/8.7/7.7	11.0/9.8/8.7/7.7	13.8/11.0/8.7/7.7	13.8/11.0/8.7/7.7	15.0/12.5/9.8/7.7	14.8/13.0/11.2/9.7	16.8/14.9/11.9/10.3	18.7/16.4/13.4/10.8	
Panel Colour	-	White	White	White	White	White	White	White	White	
Piping	Connection Type	-	Flare-nut Connection(with Flare Nuts)							
	Liquid	mm	Φ 6.35	Φ 6.35	Φ 6.35	Φ 6.35	Φ 6.35	Φ 9.53	Φ 9.53	Φ 9.53
		inch	1/4	1/4	1/4	1/4	1/4	3/8	3/8	3/8
	Gas	mm	Φ 12.7	Φ 12.7	Φ 12.7	Φ 12.7	Φ 12.7	Φ 15.88	Φ 15.88	Φ 15.88
inch		1/2	1/2	1/2	1/2	1/2	5/8	5/8	5/8	
Condensate Drain	mm	O.D.32								
Weight	Net Weight	kg	13.5	13.5	13.5	13.5	13.5	16.0	16.0	16.0
	Gross Weight	kg	17	17	17	17	17	20	20	20
Dimensions	External	H mm	315	315	315	315	315	315	315	315
		W mm	960	960	960	960	960	1120	1120	1120
	Packaging	D mm	230	230	230	230	230	230	230	230
		H mm	445	445	445	445	445	438	438	438
Packaging	W mm	1080	1080	1080	1080	1080	1238	1238	1238	
	D mm	355	355	355	355	355	349	349	349	

NOTES:

- The nominal cooling capacity and heating capacity are based on the following conditions:
Cooling Operation Conditions
Indoor Air Inlet Temperature: 27°C DB(80°F DB), 19.0°C WB(66.2°F WB)
Outdoor Air Inlet Temperature: 35°C DB(95°F DB)
Piping Length: 7.5 Meters Piping Lift: 0 Meter
Heating Operation Conditions
Indoor Air Inlet Temperature: 20°C DB(68°F DB)
Outdoor Air Inlet Temperature: 7°C DB(45°F DB), 6°C WB(43°F WB)
- The sound pressure level is based on the following conditions:
1.1m beneath the unit and 1.0m from inlet grille.
Voltage of the power source for the indoor fan motor is 220V.
In case of the power source of 240V, the sound pressure level increases by about 1~2dB.
The above data was measured in an anechoic chamber so that the reflected sound should be taken into consideration in the field.

INDOOR UNIT



Convenient design

Advanced structure design makes the unit installation, pipe connection, wiring work easier.



Wider 3D-airflow range

Broad air deflector design realizes broad air supply range. The wind direction can be adjusted according to the need thus it can make the customers feel more comfortable.

NOTE: This function can be achieved by the wired controller: HYXE-J01H, HYXE-VA01, HYXM-VB01, HYXE-M01H

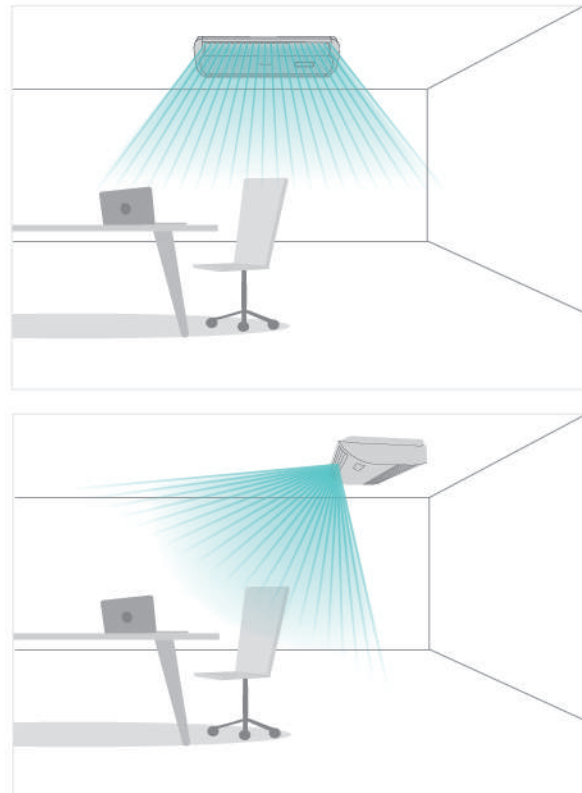

Ceiling & Floor Type



Model		AVV-17URSCA	AVV-18URSCA	AVV-22URSCA	AVV-24URSCA	AVV-27URSCB	AVV-30URSCB	AVV-38URSCB	AVV-48URSCC	
Power Supply		AC 1Φ, 220V~240V/50Hz/60Hz								
Capacity	Cooling	kW	5.0	5.6	6.3	7.1	8.4	9.0	11.2	14.2
		Btu/h	17,100	19,100	21,500	24,200	28,700	30,700	38,200	48,500
Capacity	Heating	kW	5.6	6.5	7.5	8.5	9.6	10.0	13.0	16.3
		Btu/h	19,100	22,200	25,600	29,000	32,800	34,100	44,400	55,600
Power Input	Cooling	W	40	40	70	70	70	80	130	160
	Heating	W	40	40	70	70	70	80	130	160
Sound Pressure	Ceiling	dB(A)	39/35/30	39/35/30	45/41/37	45/41/37	43/39/34	45/40/36	51/46/40	50/46/42
	Floor	dB(A)	43/38/35	43/38/35	48/44/40	48/44/40	46/41/37	48/43/39	54/49/43	55/50/46
Airflow Rate		m ³ /min	13.0/11.0/9.0	13.0/11.0/9.0	16.1/14.0/11.3	16.1/14.0/11.3	18.2/15.2/12.2	19.4/16.3/13.3	24.8/20.5/16.3	33.0/28.0/23.0
Speed-up Setting HH1		m ³ /min	14.2	14.2	17.8	17.8	19.8	21.2	27.0	36.0
Speed-up Setting HH2		m ³ /min	16.0	16.0	20.0	20.0	22.3	23.5	29.2	37.4
Panel Colour			Neture White	Neture White	Neture White	Neture White	Neture White	Neture White	Neture White	Neture White
Piping	Connection Type		Flare-nut Connection(with Flare Nuts)							
	Liquid	mm	Φ 6.35	Φ 6.35	Φ 9.53	Φ 9.53	Φ 9.53	Φ 9.53	Φ 9.53	Φ 9.53
		inch	1/4	1/4	3/8	3/8	3/8	3/8	3/8	3/8
	Gas	mm	Φ 15.88	Φ 15.88	Φ 15.88	Φ 15.88	Φ 15.88	Φ 15.88	Φ 15.88	Φ 15.88
inch		5/8	5/8	5/8	5/8	5/8	5/8	5/8	5/8	
Condensate Drain	mm	O.D.32								
Weight	Net Weight	kg	31	31	32	32	39	40	41	47
	Gross Weight	kg	38	38	39	39	46	47	48	56
Dimensions	External	H mm	230	230	230	230	230	230	230	230
		W mm	990	990	990	990	1285	1285	1285	1580
	Packaging	D mm	680	680	680	680	680	680	680	680
		H mm	340	340	340	340	340	340	340	340
Packaging	W mm	1110	1110	1110	1110	1400	1400	1400	1690	
	D mm	830	830	830	830	830	830	830	830	

NOTES:

1. The nominal cooling capacity and heating capacity are based on the following conditions:
 Cooling Operation Conditions
 Indoor Air Inlet Temperature: 27°C DB(80°F DB), 19.0°C WB(66.2°F WB)
 Outdoor Air Inlet Temperature: 35°C DB(95°F DB)
 Piping Length: 7.5 Meters Piping Lift: 0 Meter
 Heating Operation Conditions
 Indoor Air Inlet Temperature: 20°C DB(68°F DB)
 Outdoor Air Inlet Temperature: 7°C DB(45°F DB), 6°C WB(43°F WB)

2. The sound pressure level is based on the following conditions:
 1.0m beneath the unit, 1.0m from Discharge Grille.
 The above data was measured in an anechoic chamber so that the reflected sound should be taken into consideration in the field. When bottom air inlet is adopted, sound pressure will increase according to factors such as installation mode and the room structure.

INDOOR UNIT



Connectable devices

Third party accessories like air return filters, fresh air introduction and humidity sensors are all connectable to the Floor Concealed Type.

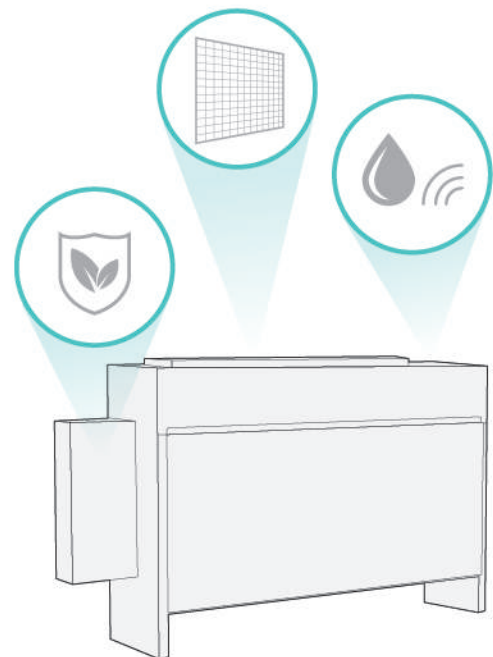

Space saving

Floor Concealed Type is designed to be installed on floors completely concealed into the walls, which is slim and compact with only height of 620mm to be hidden under half-heighted windows.

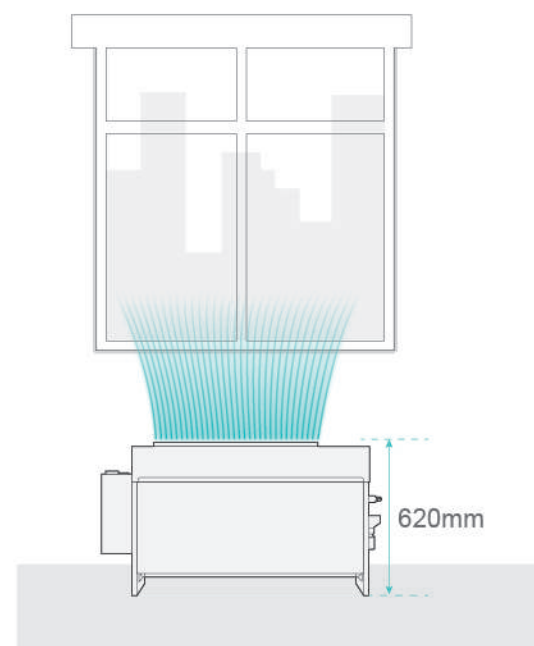

Floor Concealed Type



Model		AVH-09UXCSAA	AVH-14UXCSAA	AVH-18UXCSBA	AVH-24UXCSBA	
Power Supply		AC 1Φ, 220V~240V/50Hz				
Model		AVH-09UX2SAA	AVH-14UX2SAA	AVH-18UX2SBA	AVH-24UX2SBA	
Power Supply		AC 1Φ, 220V/60Hz				
Capacity	Cooling	kW	2.8	4.3	5.6	7.1
		Btu/h	9,600	14,700	19,100	24,200
Power Input	Heating	kW	3.3	4.9	6.5	8.5
		Btu/h	11,300	16,700	22,200	29,000
Sound Pressure	Cooling	dB(A)	34/31/27	40/36/34	41/36/32	44/40/36
	Heating	dB(A)	34/31/27	40/36/34	41/36/32	44/40/36
Airflow Rate		m ³ /min	8.5/7.5/6.3	10.3/9.0/8.0	14.8/12.3/10.5	16.3/13.8/11.8
Connection Type		Flare-nut Connection(with Flare Nuts)				
Piping	Liquid	mm	Φ 6.35	Φ 6.35	Φ 6.35	Φ 9.53
		inch	1/4	1/4	1/4	3/8
	Gas	mm	Φ 12.7	Φ 12.7	Φ 15.88	Φ 15.88
		inch	1/2	1/2	5/8	5/8
Condensate Drain	mm	O.D.32				
Weight	Net Weight	kg	18	22	26	27
	Gross Weight	kg	30	31	37	37
Dimensions	External	H mm	620	620	620	620
		W mm	948+139	948+139	1218+139	1218+139
	Packaging	D mm	202	202	202	202
		H mm	675	675	675	675
	Packaging	W mm	1160	1160	1430	1430
		D mm	240	240	240	240

NOTES:

1. The nominal cooling capacity and heating capacity are based on the following conditions:
 Cooling Operation Conditions
 Indoor Air Inlet Temperature: 27°C DB(80°F DB), 19.0°C WB(66.2°F WB)
 Outdoor Air Inlet Temperature: 35°C DB(95°F DB)
 Piping Length: 7.5 Meters Piping Lift: 0 Meter
 Heating Operation Conditions
 Indoor Air Inlet Temperature: 20°C DB(68°F DB)
 Outdoor Air Inlet Temperature: 7°C DB(45°F DB), 6°C WB(43°F WB)

2. The sound pressure level is based on the following conditions:
 1.5m meters from the unit and 1.5m meters from floor level.
 The above data was measured in an anechoic chamber so that reflected sound should be taken into consideration in the field.

All Fresh Air Indoor Unit



Create comfortable and healthy indoor environment

Create a comfortable and healthy indoor environment by introducing fresh outdoor air. By heating or cooling fresh outdoor air to keep almost the same temperature as room temperature, fresh ambient air can be adapted and then introduced into indoor room.

Higher external static pressure

Better installation flexibility at site, longer duct can be connected.

Flexible line-up

All fresh air indoor units are applicable to Hi-FLEXi S Series. General indoor units and all fresh air indoor units can be used together in Hi-FLEXi S Series system. The unit can be interfaced to central control system. It is more easy to design electrical wiring and install.

Saving energy

Besides, after filtered, fresh outdoor air in transition seasons can be drawn to indoor room directly with no need of heating or cooling operation. While fresh outdoor air is introduced, other indoor units don't bear fresh air load.

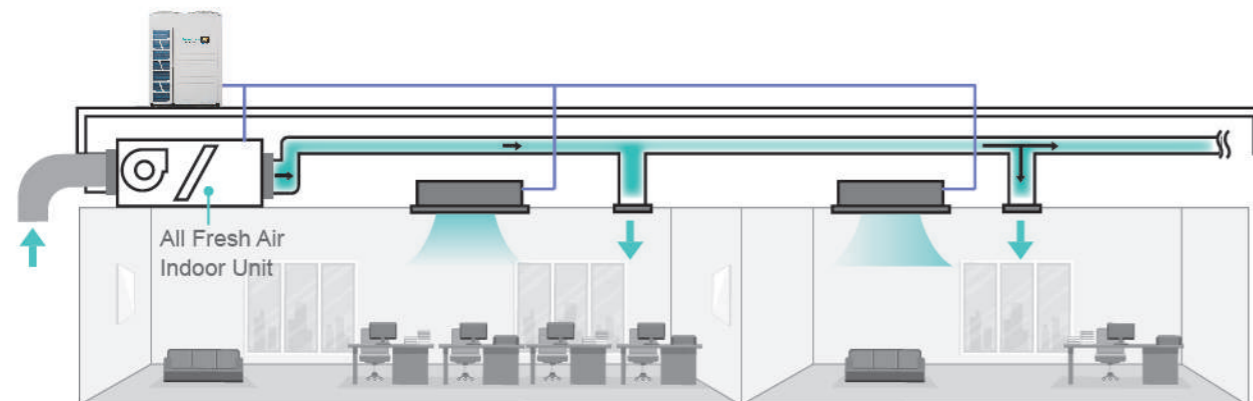
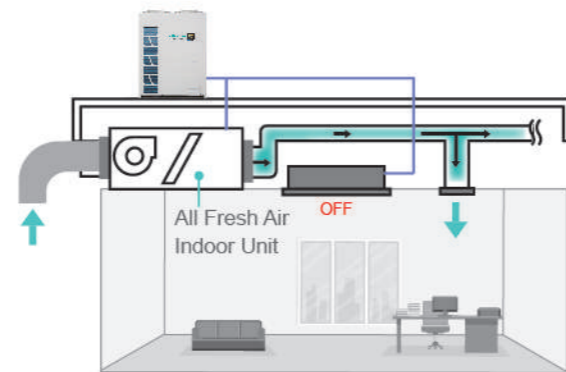

All Fresh Air Indoor Unit



Model		AVA-30UX 2SCH-70	AVA-48UX 2SQH-108	AVA-76UX 2SRH-168	AVA-96UX 2SRH-210	AVA-114UX 7SRH-300	AVA-154UX 7SSH-400	AVA-190UX 7STH-500	AVA-190UX 7tSTH-600	
Power Supply		AC 1Φ,220V/60Hz				AC 3Φ,380V/60Hz				
Capacity	Cooling	kW	9.0	14.0	22.4	28.0	33.5	45.0	56.0	56.0
		Btu/h	30,700	47,800	76,500	95,600	114,300	153,600	191,100	191,100
	Heating	kW	8.6	13.7	21.9	24.5	26.8	36.0	44.8	44.8
		Btu/h	29,400	46,800	74,700	83,600	91,500	122,900	152,900	152,900
Power Input	Cooling	W	150	330	490	510	740	1120	1330	1620
	Heating	W	150	330	490	510	740	1120	1330	1620
Sound Pressure	dB(A)	32	43	45	46	56	61	64	66	
Airflow Rate	m ³ /min	11.0	18.0	28.0	35.0	50.0	66.7	83.3	100.0	
External Static Pressure	Pa	60(120)	200	220	220	220	300	320	300	
Piping	Liquid	mm	Φ 9.53	Φ 9.53	Φ 9.53	Φ 9.53	Φ 12.7	Φ 12.7	Φ 15.88	Φ 15.88
		inch	3/8	3/8	3/8	3/8	1/2	1/2	5/8	5/8
	Gas	mm	Φ 15.88	Φ 15.88	Φ 19.05	Φ 22.2	Φ 25.4	Φ 25.4	Φ 28.6	Φ 28.6
		inch	5/8	5/8	3/4	7/8	1	1	1-1/8	1-1/8
Weight	Net Weight	kg	46	60	97	97	97	196	222	222
	Gross Weight	kg	51	64	117	117	117	240	267	267
Dimensions	External	H mm	370	370	486	486	486	635	735	735
		W mm	920	1320	1270	1270	1270	1950	1950	1950
		D mm	800	800	1069	1069	1069	805	805	805
	Packaging	H mm	390	390	1290	1290	1290	816	916	916
		W mm	1112	1512	1466	1466	1466	2213	2213	2213
		D mm	922	922	540	540	540	1006	1006	1006
Temperature Range of Fresh Air		-							Cooling: 20°C~43°C, Heating: -7°C~15°C	

NOTES:

- The nominal cooling capacity and heating capacity are based on following conditions:
Cooling operation conditions: 33°C DB, 28°C WB, piping length: 7.5m, piping lift: 0m
Heating operation conditions: 0°C DB, -9°C WB, piping length: 7.5m, piping lift: 0m
(Heating capacity is tested when defrosting is not available)
- The sound pressure level is based on following conditions: 1.5 Meter beneath the unit. The above data was measured in an anechoic chamber so that reflected sound should be taken into consideration in the field.
- An air filter with duct collection efficiency more than 50% needs to be attached to the duct system of the suction side at site.
- When the resistance of the filed-supplied duct is small, it may cause abnormal stop, malfunction, spraying water, etc. Due to excessive air flow, the duct, which is to be connected to this unit, shall be installation for dew protection.

- All fresh air indoor unit is for processing fresh air load and not for stabilizing the room temperature. For adjusting the air conditioning load of the room, the additional air conditioner is required.
- This unit shall be connected to Hi-FLEXi S Series. In case of connecting this unit with other indoor units in the same refrigerant cycle, calculate the capacity of this unit as 46.1kBTu/h(30.7kBTu/h), 71.7kBTu/h(47.8kBTu/h), 143.3kBTu/h(95.6kBTu/h).
- When Hi-FLEXi S Series is connected to only with all fresh air indoor unit, the configuration rate is 100% (Recommended).
- Under cooling mode, when outdoor temperature is lower than 20°C, the system will automatically shift to ventilation operation; Under heating mode, when outdoor temperature is higher than 15°C, The system will automatically shift to ventilation operation; In case inlet temperature is below -7°C, all fresh air unit will stop.

Heat Recovery Ventilator

Compact machine, Convenient installation.

The thickness of machine can be easily installed in the narrow residential ceiling. The width of the machine whose volume is under 300 m³/h is less than 600mm, which is particularly suitable for very narrow spaces in the ceiling, and can save the space of installation, it is more convenient for construction.

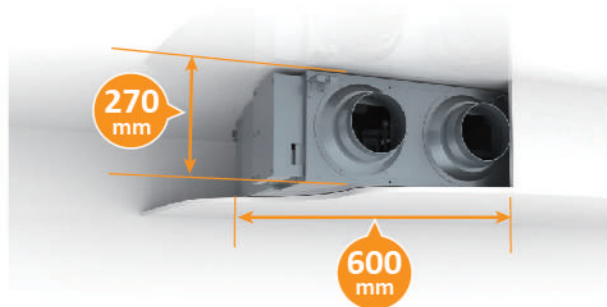

Airflow system

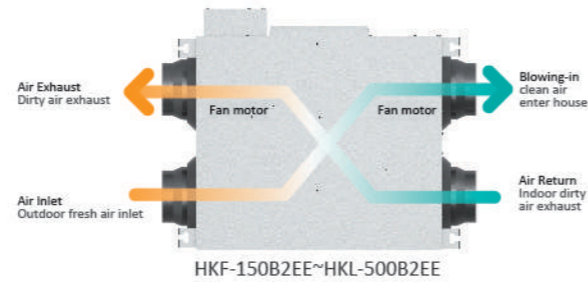
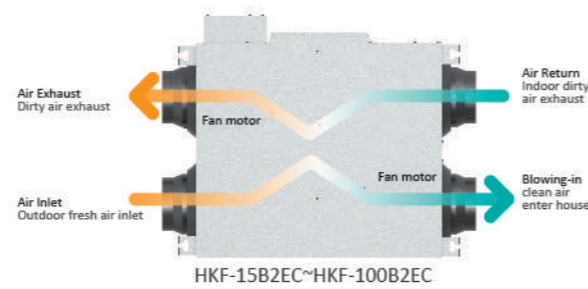

Energy saving analysis

Summer Energy Saving Analysis

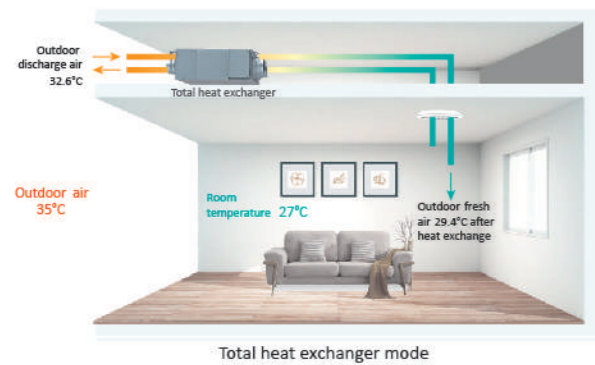

In summer operation, when the cold energy of 27°C air discharged from indoor pass through the heat exchanger, the 35°C outdoor hot air is pre-cooled to 29.4°C fresh air and supplied to indoors, as shown above, the air conditioner only needs to cool the air by 2.4°C to maintain a comfortable room temperature and fresh air. In this process, the discharge air pre-cools the fresh air by HRV, The temperature recovery efficiency in cooling is 70% max, and enthalpy exchange efficiency is 57% max.

Winter Energy Saving Analysis

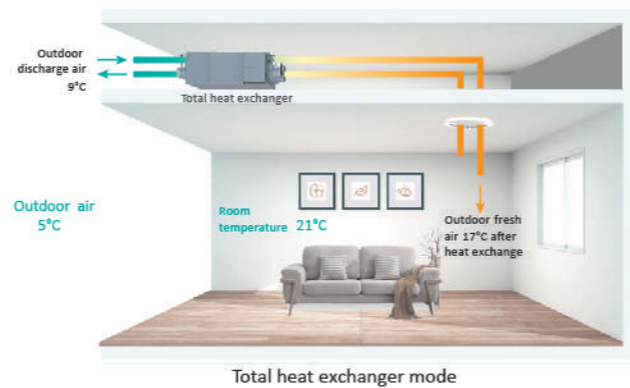

In winter operation, when the heat energy of 21°C air discharged from indoor pass through the heat exchanger, the 5°C outdoor cold air is pre-heated to 17°C fresh air and supplied to indoors, as shown above, when outdoor 5°C air and indoor 21°C air pass through the HRV, the fresh air supplied to indoors is about 17°C, the air conditioner only needs to heat the air by 4°C to maintain a comfortable room temperature and fresh air. The temperature recovery efficiency in heating is 75% max, and enthalpy exchange efficiency is 63% max.

Centralized control system

Hisense centralized control type total heat exchanger products can be connected to the centralized control system of Hisense air conditioning, achieve the linkage with air conditioning system and centralized control, so the operation is more convenient and more intelligent!



HKF-15B2EC

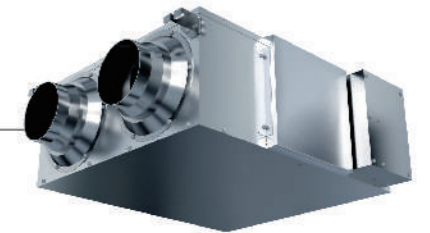

Product Dimensions

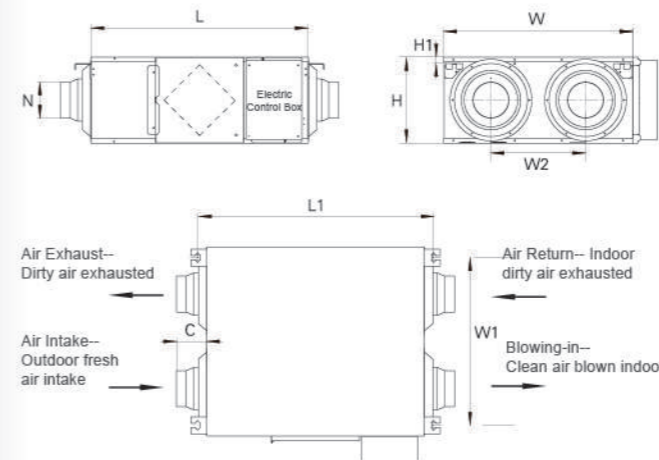

Model	L	L1	W	W1	W2	H	C	N	H1
HKF-15B2EC*	665	723	580	514	290	265	90	Ø144	20

Technical Parameters

Model	Air Volume m ³ /h			Enthalpy Efficiency (Summer) η ₁			Enthalpy Efficiency (Winter) η ₂			External Static Pressure Pa			Power Supply	Input Current A			Input Power KW			Noise Level dB(A)			Weight kg
	High	Middle	Low	High	Middle	Low	High	Middle	Low	High	Middle	Low		High	Middle	Low	High	Middle	Low				
HKF-15B2EC*	150	150	110	58	58	60	65	65	69	85	70	65	220-240V/50Hz	0.38	0.36	0.31	2x 0.041	2x 0.038	2x 0.029	30	29	28	25

*: 220V/60Hz HKF-15B2E2

Heat Recovery Ventilator

HKF-25B2EC~HKF-100B2EC

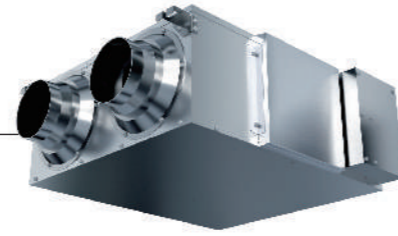

Product Dimensions

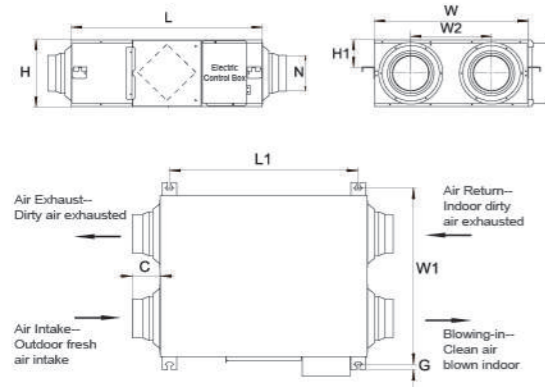

Model	L	L1	W	W1	W2	H	C	G	N	H1
HKF-25B2EC*	745	675	600	656	315	270	90	19	Φ144	110
HKF-35B2EC*	745	675	805	861	480	270	90	19	Φ144	110
HKF-50B2EC*	825	755	905	961	500	270	96	19	Φ194	110
HKF-65B2EC*	1115	1050	885	941	430	390	80	19	Φ242	175
HKF-80B2EC*	1115	1050	1135	1191	675	390	80	19	Φ242	175
HKF-100B2EC*	1115	1050	1135	1191	675	390	80	19	Φ242	175

Technical Parameters

Model	Air Volume m³/h			Enthalpy Efficiency (Summer) η _i			Enthalpy Efficiency (Winter) η _i			External Static Pressure Pa			Power Supply	Input Current A			Input Power KW			Noise Level dB(A)			Weight kg
	High	Middle	Low	High	Middle	Low	High	Middle	Low	High	Middle	Low		High	Middle	Low	High	Middle	Low	High	Middle	Low	
HKF-25B2EC*	250	250	190	57	57	59	63	63	68	85	65	60	220-240V/50Hz	0.66	0.56	0.52	2×0.069	2×0.055	2×0.049	32	31	28	30
HKF-35B2EC*	350	350	270	55	55	57	62	62	65	100	75	65		0.76	0.75	0.71	2×0.083	2×0.079	2×0.075	34	33	31	35
HKF-50B2EC*	500	500	400	56	56	58	63	63	65	130	110	100		1.82	1.71	1.52	2×0.189	2×0.157	2×0.124	39	38	36	40
HKF-65B2EC*	650	650	550	57	57	59	63	63	68	130	100	100		1.75	1.62	1.51	2×0.193	2×0.178	2×0.164	40	38	35	62
HKF-80B2EC*	800	800	650	58	58	59	66	66	68	130	100	90		1.98	1.88	1.75	2×0.211	2×0.196	2×0.18	42	40	37	72
HKF-100B2EC*	1000	1000	700	56	56	58	63	63	66	165	120	60		4.68	4.18	3.47	2×0.510	2×0.450	2×0.363	44	42	38	79

*: AC 1Φ220V/60Hz HKF-25B2E2~HKF-100B2E2

HKF-150B2EE~HKF-200B2EE

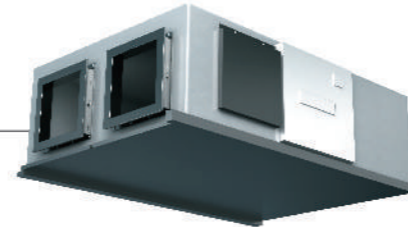

Product Dimensions

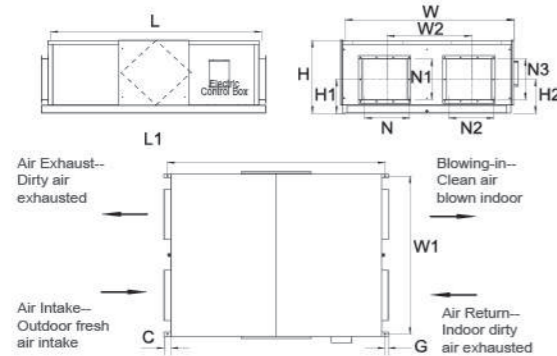

Model	L	L1	W	W1	W2	H	H1
HKF-150B2EE*	1500	1550	1200	1170	600	540	250
HKF-200B2EE*	1550	1600	1400	1370	700	540	250

Model	C	G	N	N1	N2	N3	H2
HKF-150B2EE*	50	25	320	300	320	300	250
HKF-200B2EE*	50	25	320	300	320	300	250

Technical Parameters

Model	Air Volume m³/h	Enthalpy Efficiency (Summer) η _i	Enthalpy Efficiency (Winter) η _i	External Static Pressure Pa	Power Supply	Input Current A	Input Power KW	Noise Level dB(A)	Weight kg
HKF-150B2EE*	1500	55	63	180	380~415V/50Hz	2.78	2×0.41	48	151
HKF-200B2EE*	2000	54	62	160	380~415V/50Hz	2.89	2×0.52	49	172

*: AC 3Φ220V/60Hz HKF-150B2E9 HKF-200B2E9 AC 3Φ380V/60Hz HKF-150B2EF HKF-200B2EF

HKF-250B2EE~HKF-300B2EE



Product Dimensions

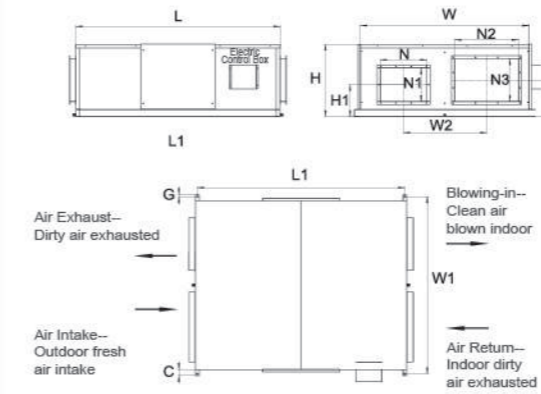

Model	L	L1	W	W1	W2	H	H1
HKF-250B2EE*	1610	1580	1330	1400	655	600	265
HKF-300B2EE*	1700	1670	1500	1570	750	640	272

Model	C	G	N	N1	N2	N3	H2
HKF-250B2EE*	50	15	365	275	500	350	300
HKF-300B2EE*	50	15	365	275	500	350	309

Technical Parameters

Model	Air Volume m³/h	Enthalpy Efficiency (Summer) η _i	Enthalpy Efficiency (Winter) η _i	External Static Pressure Pa	Power Supply	Input Current A	Input Power KW	Noise Level dB(A)	Weight kg
HKF-250B2EE*	2500	54	62	180	380~415V/50Hz	3.86	2×0.72	53	185
HKF-300B2EE*	3000	55	63	200	380~415V/50Hz	5.12	2×1.16	56	222

*: AC 3Φ220V/60Hz HKF-250B2E9 HKF-300B2E9 AC 3Φ380V/60Hz HKF-250B2EF HKF-300B2EF

HKL-400B2EE~HKL-500B2EE



Product Dimensions

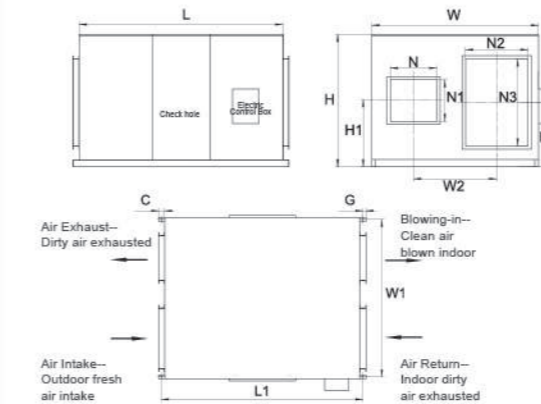

Model	L	L1	W	W1	W2	H	H1
HKL-400B2EE*	1625	1675	1330	1300	665	1050	490
HKL-500B2EE*	1625	1675	1330	1300	665	1050	490

Model	C	G	N	N1	N2	N3	H2
HKL-400B2EE*	50	25	370	330	500	690	475
HKL-500B2EE*	50	25	370	330	500	690	475

Technical Parameters

Model	Air Volume m³/h	Enthalpy Efficiency (Summer) η _i	Enthalpy Efficiency (Winter) η _i	External Static Pressure Pa	Power Supply	Input Current A	Input Power KW	Noise Level dB(A)	Weight kg
HKL-400B2EE*	4000	55	63	220	380~415V/50Hz	5.89	2×1.71	57	312
HKL-500B2EE*	5000	53	61	240	380~415V/50Hz	8.78	2×2.2	58	321

*: AC 3Φ220V/60Hz HKF-400B2E9 HKF-500B2E9 AC 3Φ380V/60Hz HKF-400B2EF HKF-500B2EF

AHU Connection Kit



The Hisense AHU-KIT can integrate external heat exchangers of Air-handling units (AHU) into a Hisense VRF system to be used for air conditioning, which can provide more flexible air conditioning solutions and save more cost in the building air conditioning renovation.

Main functions

- ◆ ON/OFF Control
- ◆ Capacity Demand
- ◆ Temperature Setting
- ◆ Operation Mode

Selection and limitation of heat exchanger of AHU

The Heat Exchanger of AHU(field-supplied)should be selected according to the following technical data and limitations.Lifetime of the outdoor unit, operation range or operation reliability may be influenced if these limitations are neglected.

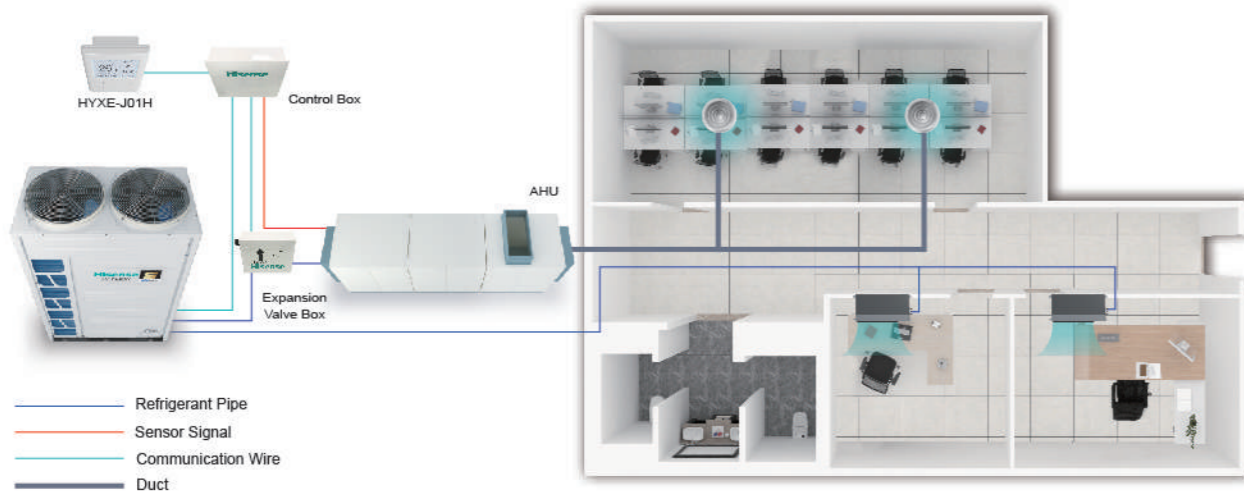

AHU Connection Kit

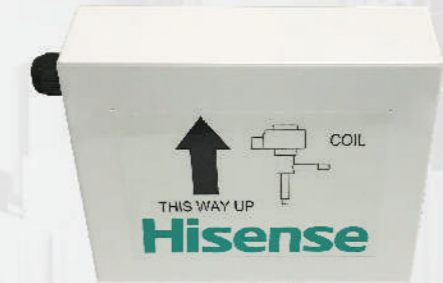

AHU Connection KIT		HZX-2.0 AEC	HZX-4.0 AEC	HZX-6.0 AEC	HZX-10.0 AEC	HZX-20.0 AEC						HZX-30.0 AEC					
Power Supply		AC 1Φ,220V~240V/50Hz,220V~240V/60Hz															
Nominal Capacity of AHU		HP	2	4	6	8	10	12	14	16	18	20	22	24	26	28	30
Allowed Heat Exchanger Capacity (H/M/L)	Cooling	kW	4.0	7.1	11.2	16.0	20.0	28.0	33.5	40.0	45.0	50.0	56.0	61.5	69.0	73.0	80.0
		kW	5.0	9.0	14.0	20.0	25.0	30.0	35.0	43.0	48.0	52.0	58.0	65.0	71.0	76.0	82.0
		kW	5.6	11.2	16.0	22.4	28.0	33.5	40.0	45.0	50.0	56.0	61.5	69.0	73.0	80.0	85.0
	Heating	kW	4.5	8.0	12.5	17.9	22.4	31.5	37.5	45.0	50.0	56.0	63.0	69.0	77.5	82.5	90.0
		kW	5.6	10.0	16.0	22.4	28.0	33.5	40.0	47.5	53.0	60.0	66.0	75.0	79.0	86.0	92.0
		kW	7.1	12.5	18.0	25.0	31.5	37.5	45.0	50.0	56.0	63.0	69.0	77.5	82.5	90.0	95.0
Heat Exchanger Volume	Min	dm³	0.57	1.03	1.92	2.92	3.89	4.76	5.85	6.79	7.57	8.47	9.04	9.50	10.39	11.39	12.36
	Max	dm³	1.16	2.37	2.92	3.89	4.76	5.91	6.89	8	8.92	9.97	11.13	12.34	12.89	13.86	14.73
Equivalent Indoor Unit Capacity		HP	2	4	6	8	10	12	14	16	18	20	22	24	26	28	30
Control Box Model		-	HZX-AEC/1														
Expansion Valve Box Model		-	HZX-2.0 AEC/2	HZX-4.0 AEC/2	HZX-6.0 AEC/2	HZX-10.0 AEC/2	HZX-20.0 AEC/2						HZX-30.0 AEC/2 2set				

Operation Conditions		Cooling	Heating
Indoor Air Inlet Temperature	DB	27.0°C	20.0°C
	WB	19.0°C	-
Outdoor Air Inlet Temperature	DB	35.0°C	7.0°C
	WB	-	6.0°C

DB: Dry Bulb; WB: Wet Bulb; Pipe Length: 7.5m; Pipe Height: 0m

CONTROL SYSTEM

The intelligent control system of Hisense central air conditioning can realize automatic control through one computer, which makes it easy to learn the overall system operation and detect and solve problems promptly. Meanwhile this system can achieve electricity household metering with humanized intelligent control and efficient and convenient management to make users enjoy the modern intelligent life.



Independent Controller

HYXE-J01H 120mm×120mm



- ◆ Choose 10 different languages you love.
- ◆ Adjust running light / keyclick
- ◆ Set humidity
- ◆ Control air louvers independently
- ◆ Dehumidification



LED Clear Display

The characteristics of LED dot matrix display is high resolution. Better precision ensures easy to see.



Temperature Sensor

You can choose temperature sensor or default setting(always return air temperature) as standard to set temperature. The temperature sensor will be more precise to ensure customers' comfort.



Connect With Hi-Motion

J01H can connect with Hi-Motion.



Weekly Timer/Holiday Setting

Turn on or off the air-conditioning after pre-setting depend on your different demand.



Backlight

The backlight display, clearly visible during day and night.



Address Setting

Do not dial-up. You can set address to accurately find every IDUs.

HYXM-VB01 86mm×90mm



Touchscreen

You interact with VB01 using your fingers to tap objects on the touchscreen instead of keyboard. 3.5 inches. It is convenient to operate with bigger screen showing.



Multilingual

12 different languages. Choose the language you love.



Auto-brightness

It can adjust the screen that is synchronous with running light for current light conditions. Dim the screen automatically to reduce light before you need to recharge air-conditioning.



Appearance

The appearance delivers the most accurate streamlined design in the industry. VB01 uses subtly hisense-designed materials that is precisely machined to create structural bands in the side. Aluminum alloy design adopts CNC technology to keep luster.



Intelligent

Match all kinds of hisense indoor units. If each air deflector can be controlled independently, the key will light. On the contrary, the key will dim and you can not tap.

- ◆ Check PCB fault by itself
- ◆ Modify the address of indoor units
- ◆ Restart after sudden power outage
- ◆ Control 6 indoor units
- ◆ Prevent children from touch by mistakes
- ◆ Set weekly timer
- ◆ Equip wireless receiver
- ◆ Dehumidification

HYXE-M01H 86mm×86mm

HYXE-VA01 120mm×120mm

- | | | |
|---------------------------------|---|---------------------|
| ◆ Cooling/Heating/Dry/Fan/Auto | ◆ Optional Setting | ◆ 72-hour Timer |
| ◆ Error Code Display | ◆ Check | ◆ Multiple Speed |
| ◆ Air Filter Cleaning Reminding | ◆ 3D-Airflow Setting | ◆ Backlight Control |
| ◆ Built-in Temperature Sensor | ◆ One Touch Test Run | ◆ Swing Louver |
| ◆ 0.5°C Temperature Setting | ◆ Max. 16 Indoor Units Can be Connected | |
| ◆ Dehumidification | | |



- | | | |
|--------------------------------|--|-----------------------|
| ◆ Cooling/Heating/Dry/Fan/Auto | ◆ 72-hour Timer | ◆ Temperature Setting |
| ◆ Check | ◆ Air Filter Cleaning Reminding | ◆ Error Code Display |
| ◆ Dehumidification | ◆ Multiple Speed/Swing Louver | ◆ Backlight |
| ◆ Wireless Control Available | ◆ Max. 6 Indoor Units Can be Connected | |

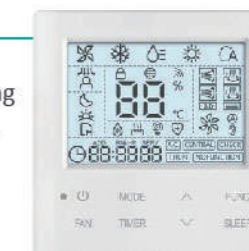

Independent Controller

HYXE-S01H 120mm×70mm

- ◆ Cooling/Heating/Dry/Fan/Auto
- ◆ 3 or 6 Speed Control
- ◆ Touch Buttons
- ◆ Optional Setting
- ◆ Dehumidification
- ◆ Quiet
- ◆ Temperature Setting
- ◆ Check
- ◆ Test Run
- ◆ Timer
- ◆ Air Filter Cleaning Reminding
- ◆ Icon Function Display
- ◆ Fan Speed/Swing Louver



HYE-W01 145mm×55mm

- ◆ Cooling/Heating/Dry/Fan/Auto
- ◆ 6 Fan Speed/Swing Louver
- ◆ Sleep Mode Setting
- ◆ Temperature Setting
- ◆ Quiet Mode Setting
- ◆ 24-hour Timer
- ◆ Dehumidification



Receiver Kit for Wireless Control (Optional)



Centralized Controller

HYJM-S01H 148mm×220mm



Multilingual

8 different languages. Choose the language you love and click "OK".

中文	English	Русский	Español
Türkçe	Deutsch	Italiano	Nederlands

Group Centralized Control

Register the searched IDUs to the group of the central controller. Max.160 indoor units (64 groups) can be connected. HYJM-S01H can show all running of each group.

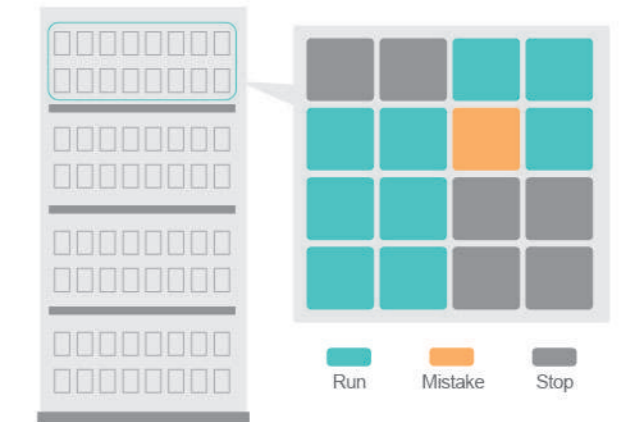

External Input/Output Setting

External Input Setting

When there is a fire, you can control all IDUs stopping with only one press in the emergency.



External Output Setting

When the system steps into the full load operation, external safety light will remind you.



Temperature Limitation

You can set higher limit of heating and lower limit of cooling to save energy.

Lock Wired Controller







Decide wired controller running mode and operation limitation.







HYJ-J01H 120mm×120mm

- ◆ Group Control(ON/OFF)
- ◆ Indoor Unit Power OFF Reminder
- ◆ External Input Setting
- ◆ Indoor Units Auto Login in
- ◆ Error Reminder
- ◆ Max. 128 Indoor Units (16 Group) Can be Connected



Centralized Controller

Type	Wired Controller					Wireless Controller	
	Model	HYXE-J01H	HYXE-VA01	HYXM-VB01	HYXE-M01H	HYXE-S01H	HYE-W01
Picture							
Suit for Indoor Unit	4-Way Cassette	○	○	○	○	○	○
	Mini 4-Way Cassette	○	○	○	○	×	○
	DC Low Height	○	○	○	○	○	○
	Ceiling Duct	○	○	○	○	○	○
	1-Way Cassette	○	○	○	○	×	○
	2-Way Cassette	○	○	○	○	×	○
	Console	○	○	○	○	○	✓
	Wall Mounted	○	○	○	○	○	✓
	Ceiling & Floor	○	○	○	○	○	✓
	Floor Concealed	○	○	○	○	×	○
	All Fresh Air Indoor Unit	○	○	○	○	○	○
	Heat Recovery Ventilation	○	○	○	✓	○	×
	3D-Airflow Panel	○	○	○	○	×	○
AHU KIT	○	✓	○	○	×	×	

Type	Receiver Kit				Centralized Controller	ON/OFF	
	Model	HYRE-V02H	HYRE-T03H	HYRE-Z01	HYRE-X01H	HYJM-S01H	HYJ-J01H
Picture							
Suit for Indoor Unit	4-Way Cassette	×	○	×	×	○	○
	Mini 4-Way Cassette	×	×	○	×	○	○
	DC Low Height	○	×	×	×	○	○
	Ceiling Duct	○	×	×	×	○	○
	1-Way Cassette	×	×	×	○	○	○
	2-Way Cassette	○	×	×	×	○	○
	Console	○	×	×	×	○	○
	Wall Mounted	○	×	×	×	○	○
	Ceiling & Floor	○	×	×	×	○	○
	Floor Concealed	○	×	×	×	○	○
	All Fresh Air Indoor Unit	○	×	×	×	○	○
	Heat Recovery Ventilation	×	×	×	×	○	○
	3D-Airflow Panel	○	×	×	×	○	○
AHU KIT	×	×	×	×	○	○	

Remarks: ✓ Standard ○ Optional × Incompatible

Hi-Mit



Main Functions

- ◆ ON/OFF Control, Operation Mode, Temperature Setting
- ◆ Operate According to a Schedule
- ◆ Display the Alarm Code
- ◆ 16 Scene Modes
- ◆ Max. 32 Indoor Units Can be Controlled
- ◆ Dimension: 215×137×38 mm

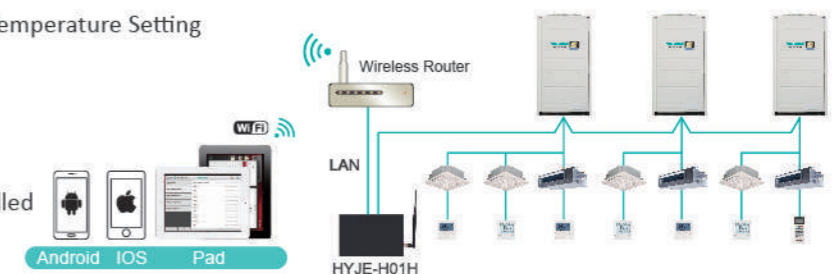

Adapter Specifications

Model Name	Input Voltage	Operating Temperature	Maximum Operating Current
HYJE-H01H	AC 110~240V 50/60Hz	0°C~40°C	10mA (220 V)

Hi-Dom Air Conditioning Management System

Centralized Control

Hi-Dom air conditioning management system adopts communication bus connection; Air conditioning indoor units are connected to the computer through network converter; The system is all controlled automatically by a computer with powerful functions and simple operation. One single computer control system can manage 4,096 indoor units.

- ◆ Running-state Monitoring
- ◆ Determine the Temperature Limit
- ◆ Running Records Display
- ◆ Access Control
- ◆ Multifunction Alarm
- ◆ Automatic Operation According to Settings
- ◆ Controller Prohibition Function
- ◆ Service Monitoring



All the indoor units and outdoor units are connected with one adapter comprise one communication BUS system.
 Max. 128 indoor units can be connected to an adapter.
 Max. 32 adapters can be controlled by one computer.
 Max. 4096 indoor units are under control.

Electric Charge Allocation

Hi-Dom air conditioning management system consists of meter reading system and air conditioning management system.
 In accordance with the operation time and capacity output of indoor and outdoor units, the electric charge allocation software allocates the total power consumption to each indoor unit.

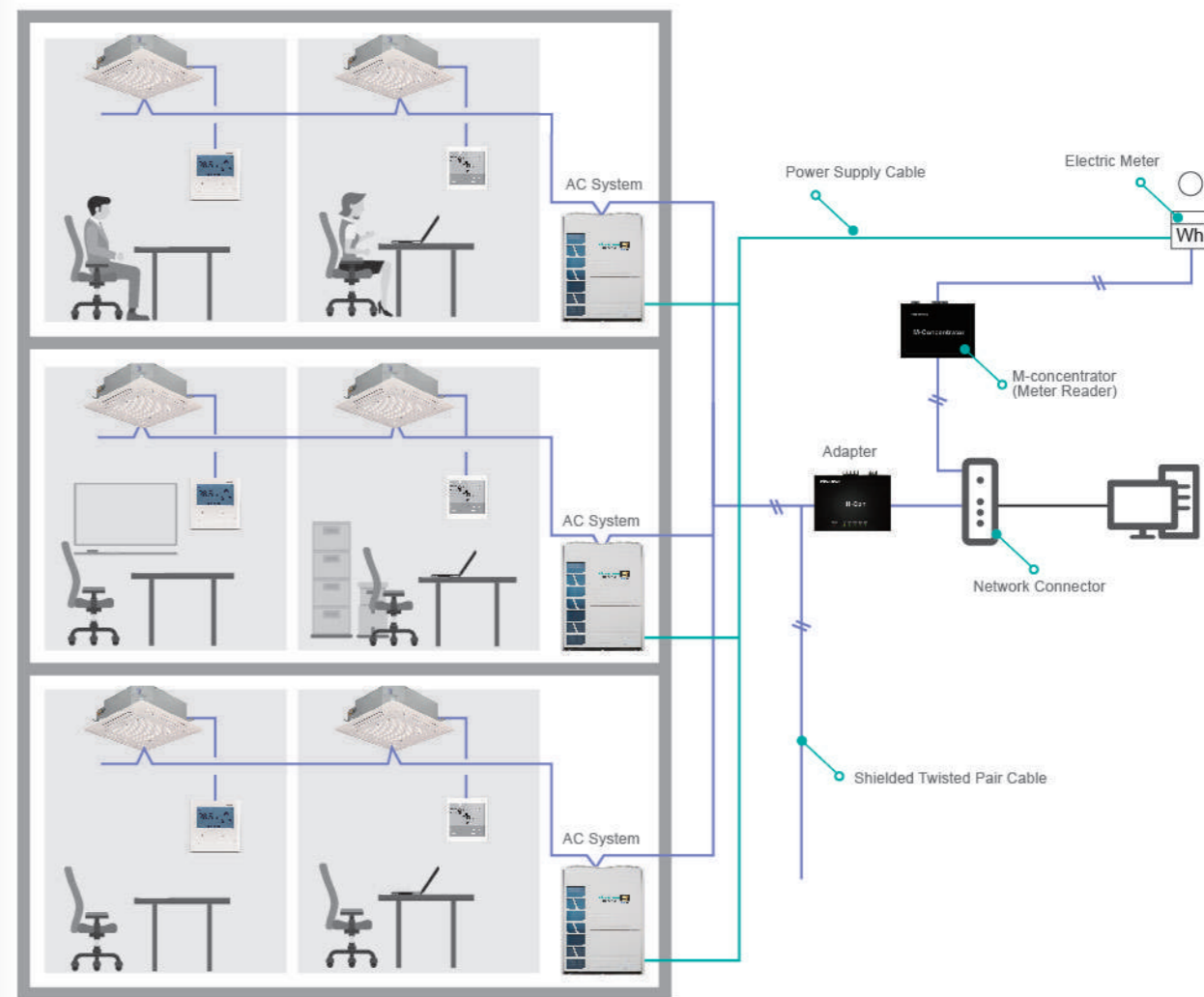

Note: Due to different laws and regulations in different regions, Hisense electrical charge calculation software need to customize processing in project according to the users' requirement.
 Only support electric meter—— iEM3150 or iEM3350, which is supplied by Schneider Electric.

Hi-Dom System Specifications

Adapter (Hi-Dom)	Model Name	Power Supply	Dimension(mm)	Charging Function
	HCCS-H128H2C1YM	DC 12V	180×110×40	With Charging Function
	HCCS-H128H2C1NM	DC 12V	180×110×40	Without Charging Function
	HCCS-H247R4C1E	DC 12V	180×110×40	—

Note: HCCS-H247R4C1E is an essential equipment for HCCS-H128H2C1YM to charging.

Building Management System

MODBUS

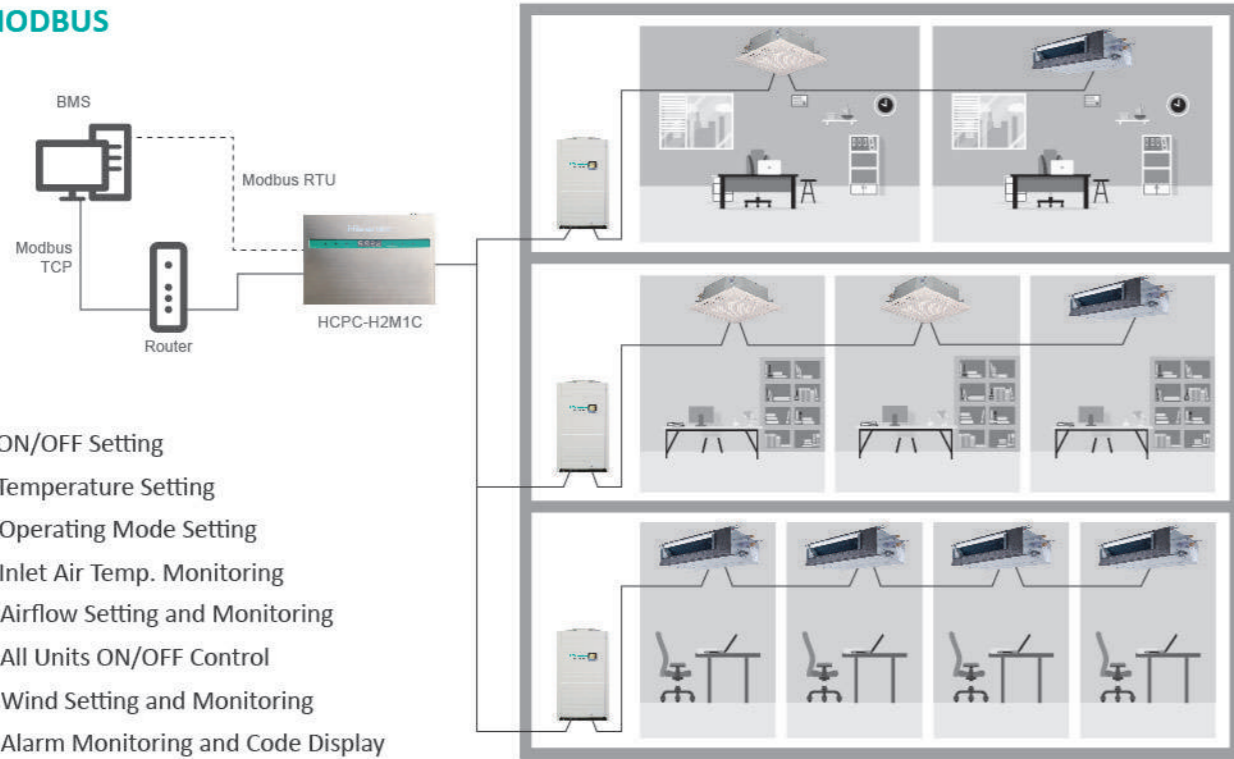

- ◆ ON/OFF Setting
- ◆ Temperature Setting
- ◆ Operating Mode Setting
- ◆ Inlet Air Temp. Monitoring
- ◆ Airflow Setting and Monitoring
- ◆ All Units ON/OFF Control
- ◆ Wind Setting and Monitoring
- ◆ Alarm Monitoring and Code Display

BACnet

Intesis Box BACnet server makes available the Hisense VRF system through independent BACnet objects. It can be applied to third party intelligent control system with BACnet/IP or BACnet MSTP protocol.

Main Functions

- ◆ Central Control of All Indoor Units
- ◆ Indoor Unit Data Monitoring
- ◆ Heat / Dry / Fan / Cool / Auto Mode Control
- ◆ Vane Position Swing Control
- ◆ Function Prohibition of Wired Controller

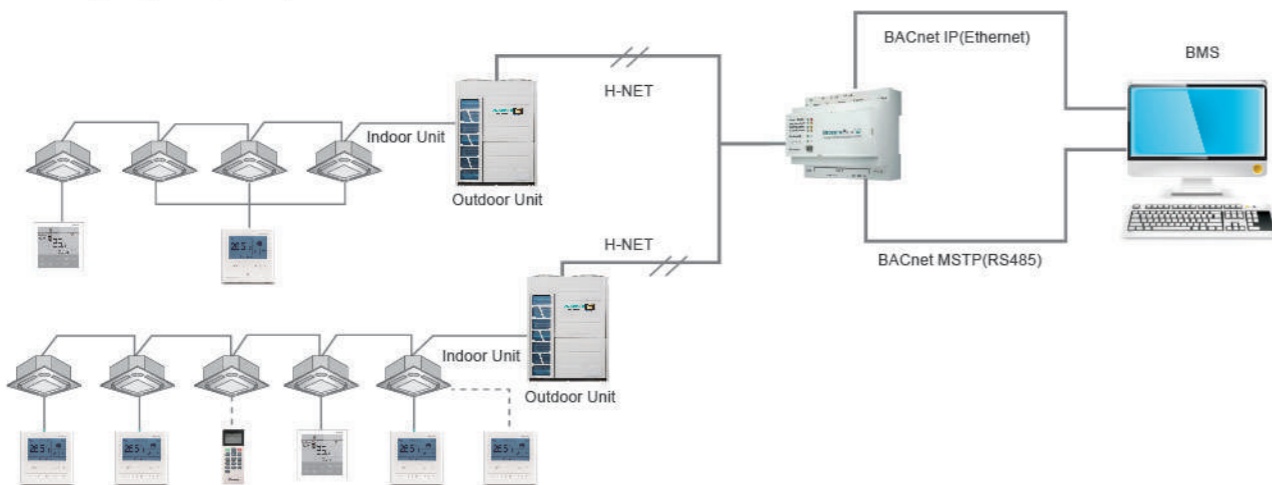

KNX

Intesis Box KNX gateways for air conditioners offers the largest range of gateways in the market for AC system integrations. These solutions offer a huge compatibility to all the KNX manufactures, and can be controlled by a simple KNX thermostat, advanced KNX touch panels or APPs.

Main Functions

- ◆ Function Prohibition of Controller
- ◆ Operation Control(ON/OFF, Temp. Setting, Mode Control etc.)
- ◆ Indoor Unit Data Monitoring
- ◆ Alarm Monitoring and Code Display
- ◆ Bidirectional Communication and Simultaneous Control from KNX and AC's Controller

One to One

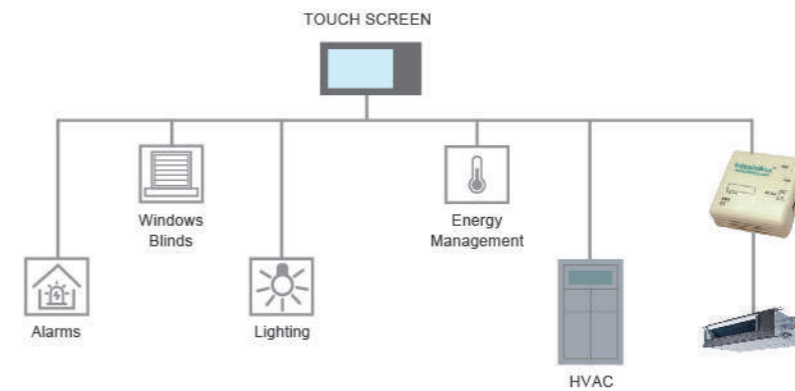

More to One

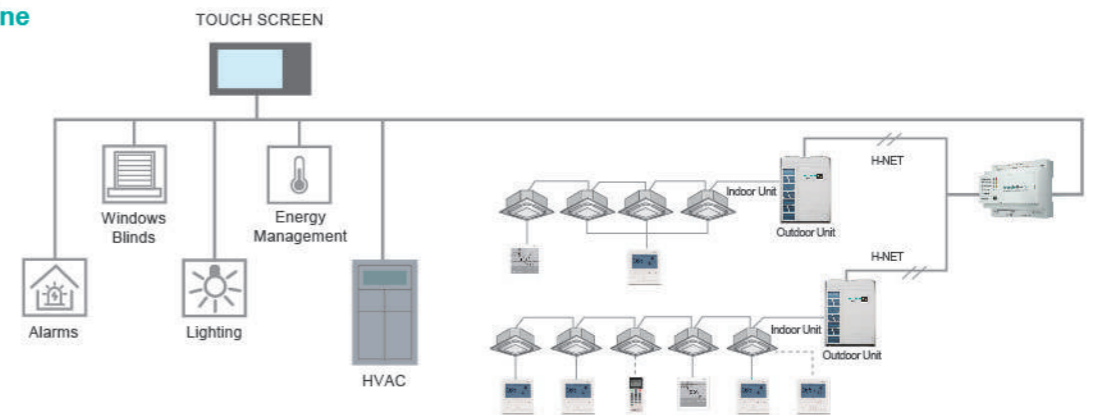

Protocol	Model	H(mm)	W(mm)	D(mm)	Max. Number of Connectable Indoors Units
KNX	HS-RC-KNX-1i	70	70	28	1
KNX	HS-AC-KNX-16	90	88	56	16
KNX	HS-AC-KNX-64	90	88	56	64
BACnet	HS-AC-BAC-16	90	88	56	16
BACnet	HS-AC-BAC-64	90	88	56	64
Modbus	HCPC-H2M1C	50	220	140	64

OPTIONAL PART

Hi-Motion

Model	Applicable Models	Picture
HCM-S01E	All indoor unit except 4-way cassette type and mini 4-way cassette type	

Motion Sensor

Model	Applicable Models	Picture
HPS-MACN	Mini 4-way cassette type	
HCM-O1E	4-Way cassette type	

Fresh Air Duct Adapter

Model	Applicable Models	Picture
HFL-S6CSA	4-Way cassette type and mini 4-way cassette type	

Humidity Sensor

Model	Applicable Models	Picture
HCHR-S01E	4-Way cassette type, Console, Ceiling Ducted Type	

Filter

Filter model	Filter Dimension	Frame Dimension
HF-224L-FE	782×165mm	1055×463mm
HF-280L-FE	1050×165mm	1245×463mm

Drain Pump

Model	Applicable Models	Power Supply
HPS-F133E	AVD-07-24HCFCH	220-240V/50Hz
	AVD-07-24HCFCL	
HPS-F363E	AVD-27-54HCFCH	
	AVD-27-54HCFCL	
HPS-F134E	AVD-07-24H3FCH	208-230V/60Hz
HPS-F364E	AVD-27-54H3FCH	

Note: For Low/High Ceiling Ducted Type only.

3D Air-flow Panel

Panel Model	Applicable Models	Outer Dimensions (H×W×D)	Interface Dimension(H×W)
HP-DB-NA	For ceiling ducted type (DC/ AC low- height) 0.8-1.5HP	180×950×70mm	750×130mm
HP-EB-NA	For ceiling ducted type (DC/ AC low- height) 1.8-2.5HP	180×1220×70mm	1020×130mm